



User Manual

snom 870

ENGLISH

© 2009 snom technology AG

snom technology AG
Charlottenstr. 68-71
10117 Berlin
Germany

Tel.: +49 30 398330
Fax: +49 30 39833111

www.snom.com

man_snom870_y101_en

COPYRIGHT, TRADEMARKS, GPL, LEGAL DISCLAIMERS

snom, the names of snom products, and snom logos are trademarks owned by snom technology AG. TeamSpirit ® VoiceEngine is Copyright © 1995-2009, SPIRIT. All other product names and names of enterprises are the property of their respective owners.

snom technology AG reserves the right to revise and change this document at any time, without being obliged to announce such revisions or changes beforehand or after the fact.

Texts, images, and illustrations and their arrangement in this document are subject to the protection of copyrights and other legal rights worldwide. Their use, reproduction, and transmittal to third parties without express written permission may result in legal proceedings in the criminal courts as well as civil courts.

When this document is made available on snom's web page, snom technology AG gives its permission to download and print copies of its content for the intended purpose of using it as a manual. No parts of this document may be altered, modified or used for commercial purposes without the express written consent of snom technology AG.

Although due care has been taken in the compilation and presentation of the information in this document, the data upon which it is based may have changed in the meantime. snom therefore disclaims all warranties and liability for the accurateness, completeness, and currentness of the information published, except in the case of intention or gross negligence on the part of snom or where liability arises due to binding legal provisions.

Our firmware includes some source code that may be used and modified by anyone and everyone under the GNU Public License (GPL), provided they, in turn, make it available to everyone else with the same licensing agreement. Please go to <http://www.snom.com/en/support/download/gpl-quellcode/> for the original GPL license and the source code of components licensed under GPL and used in snom products.

© 2009 snom technology AG
All Rights Reserved.

IMPORTANT INFORMATION

Please read the instructions on phone safety and disposal and on how to set up and use the phone before using the device and also give them to other users to read or inform those users of their contents. Save this manual and do not give the phone to third parties without it.

SAFETY INSTRUCTIONS



Follow the instructions in this manual and other applicable documentation of the phone.



Use only the power adapter delivered with the phone. Other power adapters may damage or even destroy the phone.



Avoid placing the phone's power cable where people may trip over it. Avoid placing the phone's power cable where it may be exposed to mechanical pressure as this may damage the cable. If the power supply cord or the plug is damaged, disconnect the phone and contact qualified service personnel.



This device is for indoor use only! No outdoor use!



Do not install the phone in rooms with high humidity (for example, in bathrooms, laundry rooms, damp basements). Do not immerse the phone in water and do not spill or pour liquids of any kind onto or into the phone.



Do not install the phone in surroundings at risk for explosions (paint shops, for example). Do not use the phone if you smell gas or other potentially explosive fumes.



Do not use the phone during thunderstorms. Lightning striking the power grid may cause electric shocks.

- CE** This phone is CE and FCC-certified and meets European and US health, safety, and environmental standards. Unauthorized opening, changing, or modifying the phone will cause the warranty to lapse and may also result in the lapse of the CE and FCC certifications. In case of malfunction contact authorized service personnel, your seller, or snom.
- FCC**

DISPOSAL OF THE PHONE



This phone is subject to European Directive 2002/96/EC and may not be disposed of with general household garbage.

The separate collection and proper disposal of electrical and electronic devices serve to protect human health and the environment as well as to use and reuse resources prudently and rationally.

If you do not know where you may dispose of the device at the end of its lifespan, contact your municipality, your local waste management provider, or your seller.

CLEANING



To clean the device, use an anti-static cloth. Please avoid cleaning liquids as they might damage the surface or internal electronics of the phone.

NOTATIONAL CONVENTIONS

Throughout this manual, you will see notations like the below-listed.

1. Arrows up/down: Navigation in menus and lists. Geometric arrow symbols in this manual indicate:

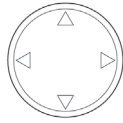

	△	Press up arrow on navigation key
	▽	Press down arrow on navigation key
	◀	Press left arrow on navigation key
	▶	Press right arrow on navigation key

2. Confirmation and cancellation of actions.

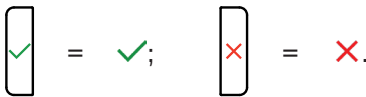
- a. The hard keys are represented by symbols:





- b. Display touch buttons.

: Tap icons/buttons to confirm/initiate actions/selections/functions. The icon/button turns yellow. Examples:  











: Tapping the button or pressing the **X** hard key will return the display to the previous screen.

 : In the Settings menus tapping the arrow button or the **X** hard key will return the display to the previous screen; tapping  will return the display to the springboard.

3. Menu item numbers: Represented by number and title, e.g., "5 Maintenance".
4. Sequences of actions to be taken. The character **>** indicates the next step in a sequence of actions to change a setting or perform a function.

- a. Example 1:

 /  > 1 Preferences > 2 Time Zone >  /  /  /  > tap selected button

 / 	Press the hardkey or tap the icon on the display to open the Settings menu
> 1 Preferences	Next, tap the "1 Preferences" button or press the number "1" key on the alphanumeric keypad.
> 2 Time Zone	Next, tap the "2 Time Zone" button or press the number "2" key on the alphanumeric keypad.
>  /  /  / 	Scroll through the list with the help of the arrow keys or with fingertip scrolling - see "Using the Touchscreen" on page 17
> tap selected button	Tap the button of your time zone (country/city) with your fingertip to save your selection and return to the previous screen.

- b. Example 2: Web interface > Advanced > Behavior > Phone Behavior > Number Guessing >  on

Web interface	Open the phone's web interface (see "The Phone's Web Interface" on page 26 on how to do it)
> Advanced	Click on the item "Advanced" in the menu on the left side of the window
> Behavior	Next, click on the tab labelled "Behavior". The bold lettering of the title on a tab indicates that its contents are currently visible.
> Phone Behavior	Find the section titled "Phone Behavior"
> Number Guessing	Find the item "Number Guessing"
>  on	Click on the radio button "on"

SETTING UP THE PHONE

DELIVERY CONTENT

Please check whether the package contains the following parts:

1. Base phone unit
2. Footstand with bracket and 2 screws
3. Handset
4. Handset cord
5. Ethernet cable
6. Power supply 5 V DC with EU/US connector

PLEASE NOTE: Using the wrong power supply may cause damage to the phone. Use only the power supply included with the phone.

PHONE INSTALLATION AND INITIALIZATION

snom phones are plug-and-play. Once you have connected the hardware and entered the data required by your provider or network administrator, you are good to go.

Installation

1. Connect the long end of the handset cord to the connector labelled "H" on the back of the phone. Connect the short end of the handset cord to the handset.
2. Place the cord in the cable guide in the right lower corner on the back of the phone.

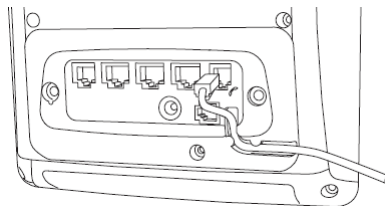

3. Attach the footstand with the bracket and the 2 screws. Choose between 55° or 33° inclination.

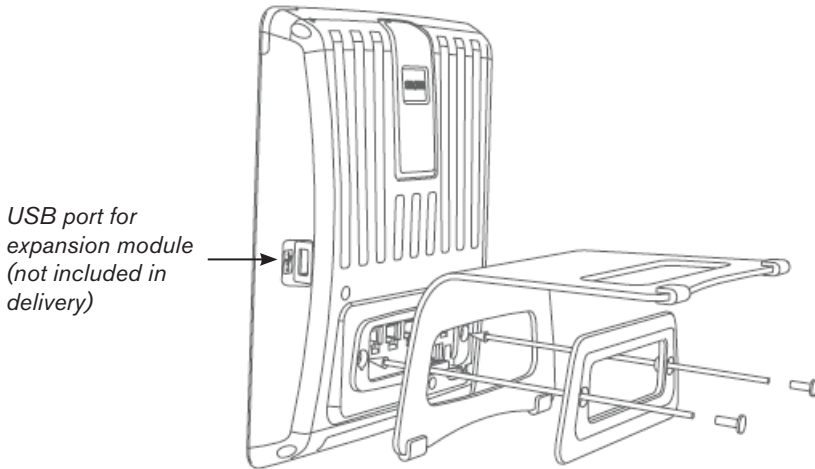

4. Plug the Ethernet (network) cable into the RJ45 connector labeled “NET”, and plug the other end into the network side to establish a data link. The second RJ45 connector, labeled “PC”, is for daisy-chaining further Ethernet devices without the need for a second Ethernet connection line.
5. If you are not using PoE, insert the plug of the power supply into the connector labeled “DC 5V”, and hook up the plug to the wall outlet.
6. If you want to use a headset, connect it to the RJ audio jack labeled **2**.
If you want to use a wireless headset, connect the snom Wireless Headset Adapter to the connector labeled "EHS".
7. Place the phone on an even, horizontal surface.

Initialization and registration

PREREQUISITES

To be able to use VoIP, you or your company need to have:

1. A broadband internet connection.
2. Access to the internet via a router. This could be a separate device available in various versions from many different manufacturers or in the form of a router on a server or a PC.
3. Account information provided by your network administrator or a VoiP account with a VoIP service provider who supports the VoIP SIP standard. You can use up to 12 VoIP accounts with one or more VoIP providers.

You need to obtain the necessary data to register your phone and make phone calls from your VoIP service provider or your network administrator. Required and optional data differ from provider to provider. They may include:











- a. Account (usually the phone number) (required)
- b. Registrar (required)
- c. Password, user name, authentication name, outbound proxy (may be required), mailbox account (if provided)

In most cases your phone will register and initialize automatically. If DHCP is not available for automatic registration, you will also need the IP address, the IP gateway, and the DNS server.

INITIALIZATION AND REGISTRATION

Once you have connected the phone to the network, the initialization and registration process begins.

Do not touch any keys while registration and initialization are taking place. The process usually takes a couple of minutes.

1. You will be prompted in English to select a language. Tap  or  to show other available languages. To select, tap the language of your choice.
2. You will then be prompted in the language of your choice to select your timezone.
 - a. If necessary, tap  /  to go to beginning of preceding/following timezone. Tap  /  to move the list one display page up/down.
 - b. Tap  /  to expand the list to all entries/reduce the list to countries/cities where the phone language is spoken.
 - c. To select, tap the timezone of your choice.
3. Next prompt: Select dialtone. If necessary, tap  or  to show more countries. To select, tap the country of your choice.
4. Next prompt: "Press a key to log on". Press any key and enter the prompted data in the text fields - see "Prerequisites" on page 9. See also "Entering Letters, Numerals, and Special Characters" on page 16.

After the successful registration of the first account the display will show the home screen. The default setting is the "springboard" with 15 icons.



- Tap the  icon. Your phone was successfully registered if the display shows a bright-green phone symbol with a checkmark on it, followed by the account (phone number) you entered. See "Identities/Accounts" on page 65 for further information on registering identities.

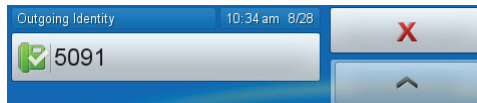

- If the phone symbol is red and the phone does not work, check on the phone's web interface whether the "Identity active" setting is "On" - see "The Phone's Web Interface" on page 26 and "Identities/Accounts" on page 65. If the setting is active, the server may be down, either for servicing or due to a malfunction. The registration and initialization again should be completed as soon as the server is up and running again. You may want to check with your administrator or your provider if nothing happens within a reasonable time.
- Don't worry if time and date are wrong. See "Correcting the Clock" on page 12 on how to change them.

WHAT TO DO IF REGISTRATION AND INITIALIZATION ARE UNSUCCESSFUL

Contact your network system administrator if the phone is operating or supposed to be operating within a network.

If you are using a VoIP provider, you may need to enter further data, as specified by your provider.

Open the phone's web interface - see "The Phone's Web Interface" on page 26. Open Configuration Identity 1, and enter any additional login information you have received from your provider - see "Configuring New Identity/Account" on page 65.

A number of IP telephony service providers and a number of SIP PBXs require settings that are different from snom's standard factory settings. snom's web page lists numerous providers and PBXs that have been tested for interoperability with our phones and specific settings that may be required. Do not change the standard configuration unless you know what you are doing. Expert help may be required.

If your IP telephone system does not support automatic initialization, contact your administrator or see our web page <http://wiki.snom.com> for manual phone initialization.

CORRECTING THE CLOCK

If the time on the display is incorrect, you may need to set the correct timezone.

1. Changing the settings on the phone: See "Time Zone" on page 68.
2. Changing the settings on the phone's web interface: See "Time Zone" on page 68.

If the time is still incorrect, there may be a problem with the time server. Contact your Administrator.

GETTING TO KNOW YOUR PHONE

This manual describes the functions of the phone with the standard factory settings. If your phone was installed and/or set up by someone else, the standard settings may have been changed. Please check with that person or company if the phone does not react as described in this manual.



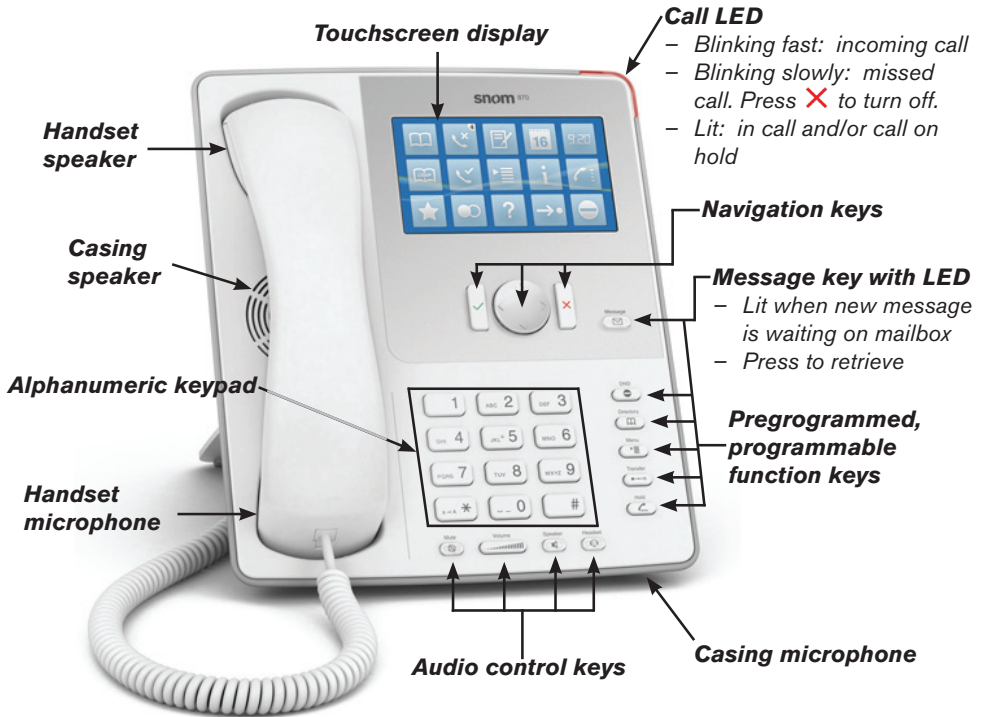



HARDWARE OVERVIEW



HARD KEYS



Navigation keys



Can be programmed with all available key events - see "The Function Keys" on page 57 for further information. Factory settings:

	Navigation key, indicated in this manual by geometric arrow symbols. See "Notational conventions" on page 6.	
		<ul style="list-style-type: none"> On idle screen: Programmable Move lists up and down one item/button at a time In Settings menu > 1 Preferences > 4 Ringer > tap identity button > press to play ringtones
		<ul style="list-style-type: none"> In text fields, press to move the cursor to the left one character at a time. On idle screen, press to open list of received calls.
		<ul style="list-style-type: none"> In text fields, press to move the cursor to the right one character at a time. On idle screen, press to open the list of missed calls
	<ul style="list-style-type: none"> Accept calls on speakerphone and in headset mode. Confirm actions/settings and return to preceding screen. Idle screen: Redial. 	
	<ul style="list-style-type: none"> Terminate calls on speakerphone and in headset and handset modes. Cancel actions and return to preceding screen. Idle screen: Turn off LED indicating missed call(s). 	

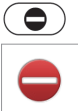



Preprogrammed, variably programmable function keys

Freely programmable. See "Configuring the Function Keys" on page 59 for further information. Factory settings:

	Message key with LED <ul style="list-style-type: none"> Lit when new message is waiting on mailbox Press to retrieve
	Turn "do not disturb" (DND) mode on and off. In DND mode incoming calls do not ring; callers hear the busy signal. Exception: Phone numbers on your directory's VIP list (see "Contact Types" on page 35). Press key to turn DND on and off. When it is on, you'll see the red DND symbol on the display.
	Phone directory. See "Directories" on page 35
	Opens the phone menu. See "The Phone Menu" on page 25

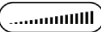
	Transfer call (if supported by PBX). See "Attended and Blind Transfer" on page 54
	Place call on hold/resume held call. See "Hold" on page 53

Audio control keys

	Adjust volume of ringer when the phone is idle or ringing Adjust volume of microphone/loudspeaker when in call
Keys with LEDs - key lights up when function is activated:	
	Mute and unmute the microphone
	Toggle between handsfree and handset mode. Dial number and accept calls on speakerphone.
	Toggle between headset and handset modes w

Alphanumeric keypad

Lift the handset, press the speaker key or any key on the alphanumeric keypad to open the edit screen. The current input mode is indicated underneath the cursor in the text field. Tap the context-sensitive button **abI** to switch to another input mode (see "Using the Touchscreen" on page 17).

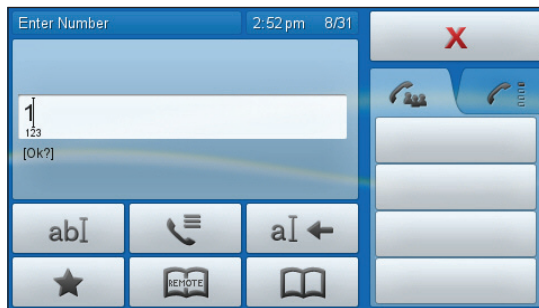

Characters underneath cursor = current input mode	Tap abI to change input mode to
123	small letters
abc	capital letters

Characters underneath cursor = current input mode	Tap abI to change input mode to
ABC	numerals

ENTERING LETTERS, NUMERALS, AND SPECIAL CHARACTERS

Switch to appropriate input mode, if necessary.

When in letter mode, press each respective key one to three (four) times quickly to type the first through third (fourth) letter printed on the key.

Press the navigation key ◀ to move the cursor to the left one character at a time. Press ▶ to move the cursor to the right one character at a time. Tap

aI ← to delete the character to the left of the cursor.

- To enter the period (.), use letter modes upper or lower case and press **(1)**.
- To enter a space (), use letter modes upper or lower case and press **(--0)** once.
- To enter an underscore (_), use letter modes upper or lower case and press **(--0)** twice.

To enter the special characters listed in the following table, use input modes upper or lower case and press **(1)** quickly as many times as indicated.

1x	.	2x	+	3x	@	4x	1	5x	:	6x	,
7x	?	8x	!	9x	-	10x	_	11x	/	12x	(
13x)	14x	;	15x	&	16x	%	17x	*	18x	#
19x	<	20x	=	21x	>	22x	\$	23x	[24x]

The Touchscreen display

COMPONENTS

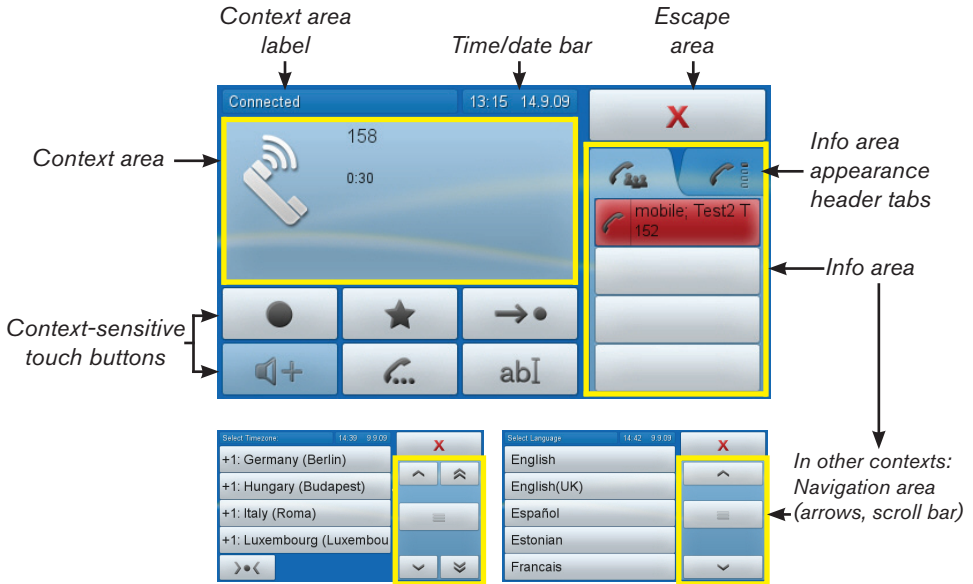

USING THE TOUCHSCREEN











1. Tap icons/buttons with your fingertip to select items, initiate and terminate actions, enter menus, turn functions on and off, etc.
 - a. If properly tapped, the icon/button/virtual function key will turn yellow. The command is executed when the fingertip leaves the icon/button.
Example: 
 - b. If you have mistakenly tapped the wrong icon/button, move your fingertip away from the yellow icon/button before lifting it off the screen. The command will not be executed.
2. Drag-and-drop keys/buttons from and into the different areas.
 - a. "Drag and drop" here means: Tap the button with your fingertip (button will turn yellow) and, without letting the fingertip lose contact with the screen, move it into another area, then lift your finger off the screen.
 - b. In some contexts the entire context area can be dragged-and-dropped into the info area.

3. Scrolling.

- a. Tap arrow buttons in navigation area - see "Components" on page 17 and "Navigation arrows" on page 33.
- b. Place a fingertip on the touchscreen and drag it lightly up or down to scroll through lists. Lift the fingertip off the screen to stop.

Escape area

Context-sensitive buttons.

	Single button - return to previous screen
	Combination of arrow + cancel buttons (menus)
	Return to idle screen
	Return to previous screen
	Combination of cancel and delete buttons (call lists, directories)
	Return to previous screen
	Delete
	Combination of "block this call" and "block all calls" buttons (incoming calls, call waiting). "Block all calls from this number" is not a factory default - see "Customizing Phone Settings" on page 65.
	Block incoming call; caller hears busy signal.
	Block incoming call and place number on deny list (list of permanently blocked numbers - see "Contact Types" on page 35); caller hears busy signal.

Context area



Yellow outlines: Touch buttons in context area

The context area shows the current activity of the phone and can contain a number of interactive elements as well as information text and symbols.

1. Interactive elements.
 - a. Text fields when dialing or editing the directory or the call lists.
 - b. Touch buttons for selecting identities, menu items, directory and call lists entries, etc.
 - c. While connected (single call) or calling a number or being called, the entire context area can be dragged-and-dropped into the info area to put the call on hold, initiate a call transfer, etc.
 - d. During a conference the context area is divided into segments, one for each phone connected to yours. Each segment can be dragged-and-dropped into the info area.

2. Information symbols and text:
 - a. Symbols (incoming call ringing, outgoing call ringing, etc.)
 - b. Text (phone number calling/being called, duration counter, etc.). If the caller is listed in your directory, the screen will also show his/her phone type (e.g., office, home, mobile), first and last name, title, organization, and e-mail.

Info area

Its contents and appearance differ, depending on phone activity and selected appearance mode.

1. While connected or calling a number or being called two appearance modes are available, call info (left tab) and virtual function keys (v.keys - right tab). Tap the tab to activate the mode. The example shows call waiting in both appearance modes: The phone is talking to 158, with 151 (mobile) ringing.

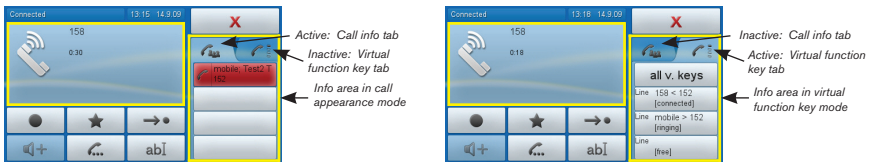

2. In other contexts, this area contains arrows for navigation or informational text.

IDLE SCREEN (HOME SCREEN)

Default setting: Springboard. Tap one of the icons to enter the function, open the menu, or initiate the action it represents.

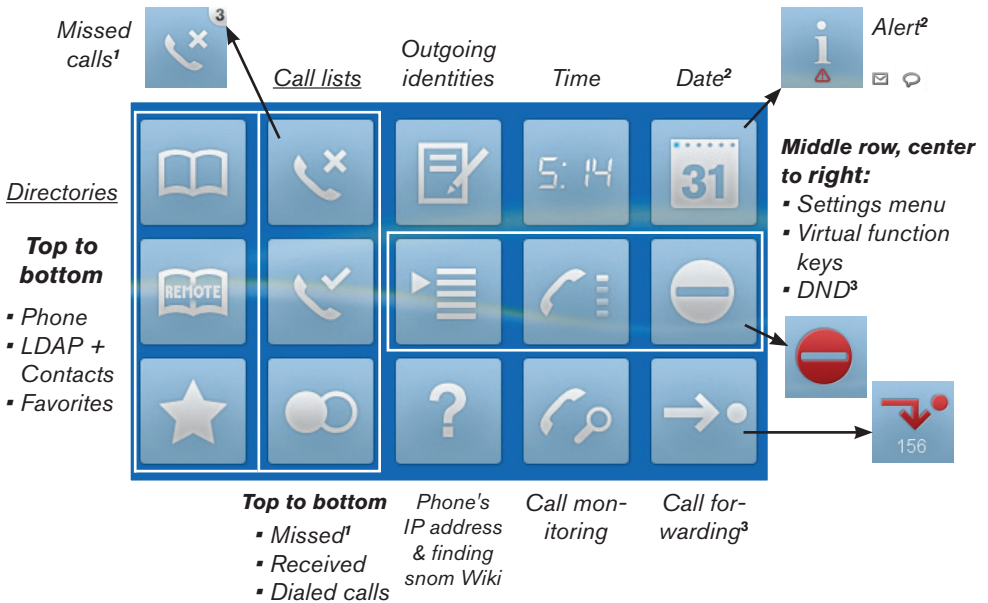

Icons with variable content:

¹ New missed calls are indicated by their number in the upper right corner.

² The date is replaced by the information alert when update is available, reboot is necessary, text /voice message has been received, etc. Touch icon to show details.

³ Symbol on icon turns red when function is turned on.

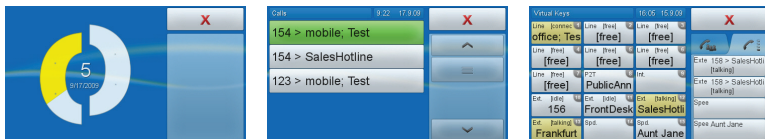

Other screens available as default idle screens: Clock, call monitoring, virtual function keys. Change the setting on the phone's web interface > Advanced > Behavior > Phone Behavior > Default Idle Screen (drop-down list) > "Save".





DIRECTORIES

Phone directory, remote directories (LDAP and contacts list), favorites: See "Directories" on page 35.

CALL LISTS

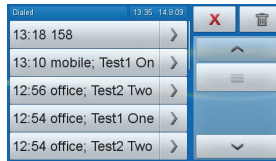
1. Tap the respective icon to open the list of missed , received , or dialed  calls.



2. To dial a number: Tap the button with the date or time/name or number of caller/callee . Tap the arrow  to show the call details.

- a. Details of missed calls:

To

From

Time: Shows the time if same day, shows date and time if not.

Missed: Total number of missed calls from this number.

- b. Details of received and dialed calls:



To

From

Time: Shows the time if same day, shows date and time, if not.





Duration: In minutes:seconds. Example: 1:14 = 1 min 14 seconds

- c. Tap  to dial the number of the missed, received or dialed call shown in detail.

- d. Tap  to add the number to the phone directory; entry details are shown on the screen. Tap  again to open edit mode. Tap the button with the detail you wish to edit. See also "Editing existing entry" on page 38.

OUTGOING IDENTITIES

To select an identity as the new outgoing identity, tap the identity tab. The display returns to the springboard.

	Active identity, currently selected as the identity for outgoing calls.
	Active identity. Can be called, can be selected for outgoing calls.
	Inactive or unregistered identity. Cannot be called from external phones or selected for external calls. May be available for internal calls depending on server setup
	Inactive or unregistered identity, currently selected as outgoing identity. Cannot be called from external phones or selected for external calls. May be available for internal calls depending on server setup

TIME, DATE

Received from NTP time server. To select your timezone, see "Time Zone" on page 68. To change the time format, see "Date and Time Formats" on page 69.

SETTINGS MENU

See page 25.

VIRTUAL FUNCTION KEYS

Freely programmable function keys. The factory default setting is "line". See "Configuring the Function Keys" on page 59.

Drag-and-drop any key into the info area on the right to show more information on the current activity of the function mapped onto it.

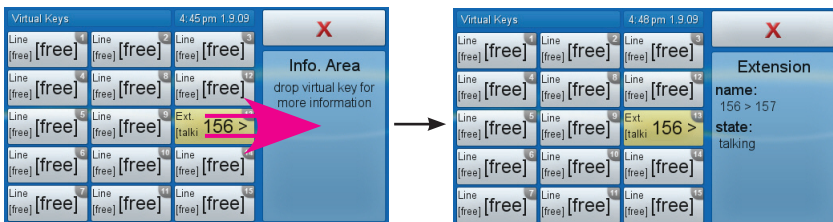

DND

Tap the icon to turn DND on and off. Works like the hard key - see page 14.

DND is off:  DND is on: 

CALL MONITORING

Screen showing calls monitored on another extension within network for call pickup when not answered, etc. Tap icon to turn on display; tap or press **X** to return to springboard. Alternative idle screen (home screen), setting on web interface > Advanced > Behavior > Phone Behavior > Default Idle Screen > Drop-down list: Call Monitoring > "Save".

Must be supported by PBX, and the function must be mapped onto one or more of the virtual function keys (see "Configuring the Function Keys" on page 59 and "Extension monitoring and call pick-up" on page 61).

Example - monitoring extension 156. 156 is listed in the phone's directory as John's office number:

1. Call ringing - 124, which is not in the directory, calling 156. If John does not answer the call, tap the green button to pick up the call.
2. Talking: When John accepts the call, the button turns white and is no longer accessible.

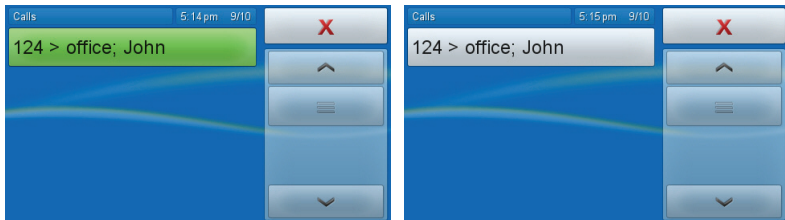

CALL FORWARDING

Turn call forwarding for all incoming calls on and off. Settings: See "Call Forwarding" on page 56 .



Call forwarding of all incoming calls is off: .

Call forwarding for all incoming calls is on, all calls will be forwarded to the number indicated: .

PHONE'S IP ADDRESS

Tap to show the phone's IP address and the web address of snom's help pages. For more information on how to open the phone's web interface, see "The Phone's Web Interface" on page 26.

Settings menu

Tap  or press  to open the settings menu. To open a lower-level menu or setting, tap its button (selected button turns yellow) or press the item's number on the alphanumeric keypad.

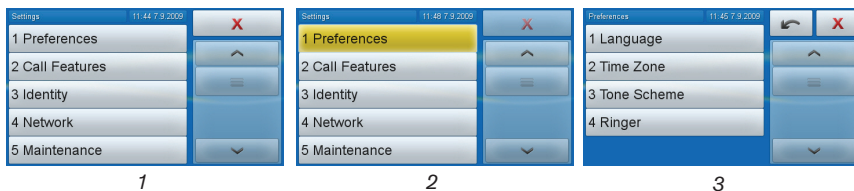

SETTINGS MENU TREE

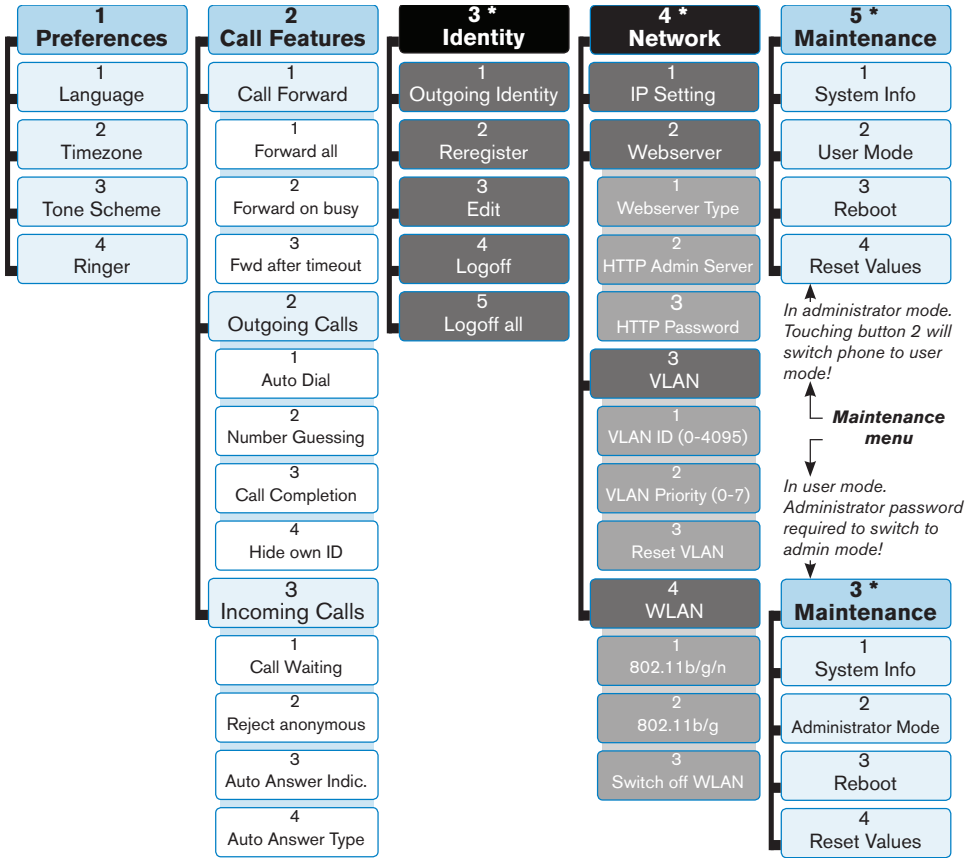

* The identity and network menus cannot be accessed when the phone is running in user mode; the maintenance menu will move to no. 3 on the top-level menu. For more information on user/administrator mode, see "User Mode/Administrator Mode" on page 29.

THE PHONE'S WEB INTERFACE

Tap  to look up the phone's IP address. Open the web browser of your PC and type http:// followed by the IP address, for example http://192.168.9.14. The web interface will open with the Security page which is shown only when the web interface is opened for the first time upon initialization or after reboot or a resetting of values:



We urge you to set administrator and HTTP passwords. The default administrator password is 0000 (4 zeros); there is no default HTTP password. If you set your own passwords, be sure to write them down and store them in a secure place.

If you do not wish to set an HTTP password, you can turn off the reminder on the phone's display until the next reboot or forever by clicking on the appropriate button. If you change your mind later, you can set the password on the phone's web interface, "Advanced"page > "QoS Security" tab > "HTTP Server" (see "Notational conventions" on page <?>) or turn off the warning later at Advanced > QoS Security > Security > Ignore security advices  > Save

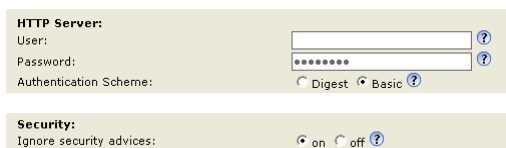

How the Web Interface Works

The vertical menu on the left side of the window is always the same, no matter which window happens to be open at the time. Available menu items depend on whether the phone is running in user or administrator mode.

Click on a menu item to open that page. Some pages contain several documents. To make a document visible, click on its tab. The font weight of the characters on the active tab is bold. Only one tab can be active at a time.

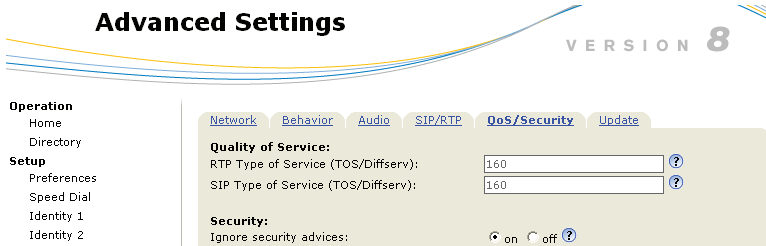

WEB SETTINGS OVERRIDING MANUAL PHONE SETTINGS

In some cases settings activated on the web interface override manual settings on the phone. If a setting you have made on the phone does not appear to take effect, look for a conflicting setting on the web interface.

Always click on Save before clicking on a different menu item or closing the web interface if you wish to save the changes you have made.

USER MODE/ADMINISTRATOR MODE

Phone

The "Identity" and "Network" menus are inaccessible in user mode. Default password for administrator mode: 0000 (4x zero).

Web interface

Some windows, like Preferences shown here, are available in user mode while many are not. The menu item Advanced is available but the settings normally found on it are not.

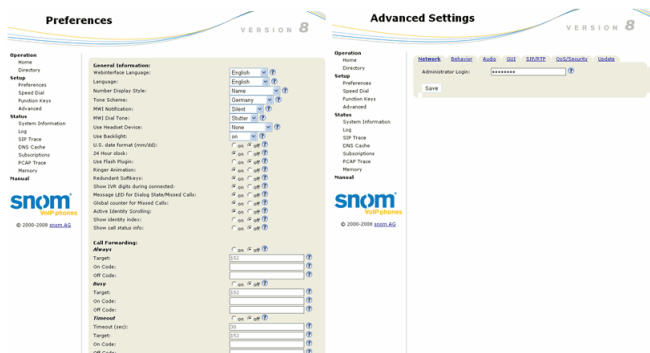



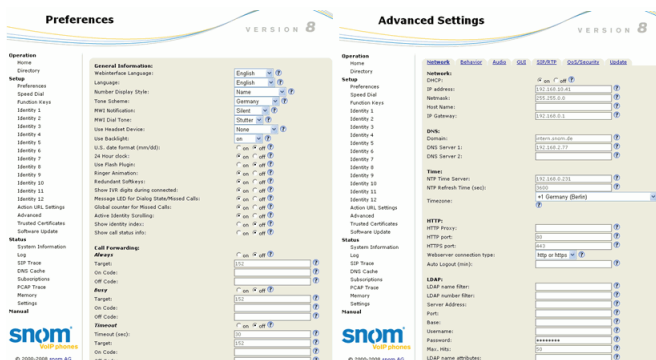



















To return the phone and its web interface to administrator mode, enter the administrator password in Administrator Login and click on "Save". The default password is 0000 (4 x zero).



DISPLAY ICONS, BUTTONS, AND INDICATIONS











Springboard

	Phone directory - see "Directories" on page 35
	Remote directories - see "External directories" on page 46
	Favorites
	 Missed calls - icon with number in upper right corner indicates new missed calls. See "Call lists" on page 22
	Received calls - see "Call lists" on page 22
	Redial (dialed calls) - see "Call lists" on page 22
	Configured identities, select outgoing identity. See "Outgoing identities" on page 22 and "Identities/Accounts" on page 65.
	Settings menu - see page 23
	Help - tap to show phone's IP address and web address of snom's Wiki help pages
	Time. Tap to show "clockface" and full date. Setting date/time format: See "Date" on page 69 and "Time" on page 70.
	Freely programmable virtual function keys - see "Virtual function keys" on page 23 and "Configuring the Function Keys" on page 59.
	Monitoring calls - see "Monitored calls screen" on page 62

		<p>Date (day) and day of the week, indicated by a bold-face dot at the top of the "calendar page" (from left to right: Mon - Sat; on Sunday the dot on the right turns yellow).</p> <p>The date is replaced by the information alert when update is available, reboot is necessary [], text [] or voice [] message has been received, etc. Tap icon to show details.</p>
		<p>DND inactive=white/active=red. Tap the icon to turn DND on and off. Works like the hard key - see page 14.</p>
		<p>Call forwarding of all calls inactive=white/active=red. Tap the icon to turn call forwarding of all calls on and off - see page 56.</p>

Context-sensitive virtual function buttons

ESCAPE AREA







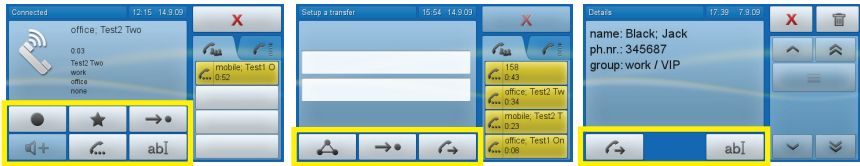

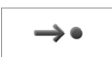

	<p>Single button - return to previous screen</p>	
	<p>Combination of arrow + cancel buttons (menus)</p>	
		<p>Return to idle screen</p>
		<p>Return to previous screen</p>
	<p>Combination cancel and delete buttons (call lists, directories)</p>	
		<p>Return to previous screen</p>
		<p>Delete</p>
	<p>Combination of "block this call" and "block all calls from this number" buttons (incoming calls, call waiting).</p>	
		<p>Block incoming call. Caller hears the busy signal.</p>
		<p>Block incoming call and place caller on deny list. This is not a factory setting. See "Contact Types" on page 35. Change setting: change at Advanced > Behavior > Deny all feature > "On".</p>

CONTEXT AREA





These are the buttons underneath the context area (outlined in yellow).







	In directories: Tap to show details buttons, tap again to enter edit mode. In call lists: Tap to show call details. Tap again to show caller details. Tap again to enter edit mode. When editing text fields: Change input mode (numerals to small letters to capital letters to numerals)
	Open call lists
	Delete character to the left of the cursor
	Open favorites list
	Add phone book entry to favorites list
	Open remote directories (LDAP, contacts, etc.)
	Open phone's directory
	Sort entries
	Show details of entry (directories, call lists)
	Merge two directory entries
	Tap icon to start recording (conversation or dictation). Must be available on server.

	Conversation is being recorded. Tap icon to stop recording.
	Put call on hold
	Transfer current call
	Turn on casing loudspeaker
	Turn off casing loudspeaker
	Expand list of time zones to show all entries
	Contract list of time zones to show only those entries where selected phone language is spoken
	Set up conference
	Open text field to enter number for dialing
	Turn on call completion when dialed number is busy
YES / NO	Confirm/cancel action
OK/ CANCEL	

NAVIGATION ARROWS

	Go to next screen
	Go to preceding screen
	Go to next letter in alphabet/beginning of next timezone
	Go to preceding letter in alphabet/beginning of preceding timezone

Display symbols

	Outgoing call ringing Call in progress		
			Incoming call ringing

If the called/calling number is in one of the directories or on the contacts list with a URL to a photograph or symbol, the default symbols are replaced by the photograph or symbol.

DIRECTORIES

PHONE DIRECTORY (INTERNAL PHONE BOOK)

The phone directory can hold 1000 entries. Entries can be added and edited on the phone and on the web interface.

Any changes you make on the web interface will not take effect until you click on "Save". Changes will be lost if you open another page of the web interface without first clicking on "Save".

Definitions, explanations

CONTACT TYPES

- **VIP:** Calls from numbers with this contact type will ring on your phone even when DND mode is active. You can assign a ringtone to this contact type. If your VIP is also assigned to a group (see below) and if that group has a distinct ringtone, the ringtone assigned to the group will be played.
- **Deny List:** Calls from phone numbers with this contact type will not ring on your phone. The caller hears the "Busy" signal.

OUTGOING IDENTITY

When an identity, with a specific VoIP provider, for example, is to be used for calls to certain phone numbers. You must dial the number from the directory, however. If you simply type it on the keypad, the current outgoing identity, as indicated on the display, will be used.

GROUP

Friends, Family, Work, Colleagues: You can assign a distinct ringtone to each group type.

ENTRIES

Each entry must have at least one phone number; multiple associated phone numbers are possible.

- **Entry with one phone number:**

John Doe, mobile 4442090	None	Identity 3			
--------------------------	------	------------	---	---	--

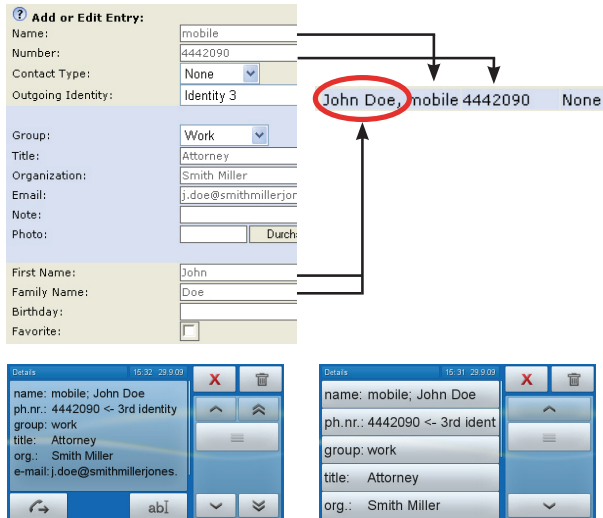

- Entry with several associated phone numbers:

Jane Doe						
- home	5552091	VIP	Active			
- mobile	4442091	VIP	Identity 3			

1. Master record. Same data on master record and on all subentries
2. Data can be different for master and each subentry. If no entries on a subentry, data from master record is displayed
3. Subentry data - one subentry for each phone number

Master record

Subentry

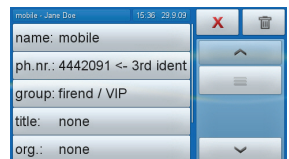
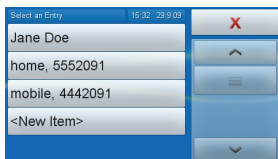

Assign Ringtones

The phone has 10 built-in ringtones. It is also possible to download a custom melody.

PLAYING RINGTONES BACK.

1. On the phone: 1 Preferences > 4 Ringer. The identities are shown on the display.
 - a. Tap an identity button to hear the current ringtone for that identity.
 - b. Press \triangle / ∇ to navigate to other ringtones. The ringtone on the button at the top of the display is played.
 - c. Tap the button to select the ringtone.
2. On the web interface (the ringtones will be played by the phone): Configuration Identity (1-12) > Login. Select a ringer from 1 to 10 in the drop-down menu of "Ringtone" and click on "Play Ringer".

ASSIGNING RINGTONES TO CONTACT AND GROUP TYPES

Preferences > Directory Ringtones.

Select a ringtone from the respective drop-down menu and click on . If you choose "Custom Melody URL", enter the URL to the data file in the text field. It must be a file of the type PCM 8 kHz 16 bit/sample (linear) mono WAV.

Adding/Editing Entries on the Phone

ADDING NEW ENTRY MANUALLY

1. Tap  to open the phone's directory.
2. Press \triangle on the navigation key to go straight to <New Item> or use navigation arrows to navigate to it, if necessary.
3. Tap <New Item> button.
4. Enter the phone number in the text field and tap the text field or press \checkmark .
5. Enter the name in the text field of "nick name" and tap the text field or press \checkmark . The "Details" screen opens.
6. Tap the button of the detail you wish to enter.
 - a. In some cases, a succession of text fields will open. Enter your data and tap field/press \checkmark or leave the field empty and tap field/press \checkmark to get to the next text field.



- b. In other cases, you will see a succession of screens with touch buttons. Example:

Group: favorites > group > contact type. Tap button to select and go to next screen. If you wish to add the entry to your "Favorites", tap the "Yes" button. Select group and contact type. In our example the entry is on the favorites list, the group is "work", and the contact type "VIP".

group: * work / VIP

7. When done, tap button  or press hardkey  to return to directory.

ADDING NEW ENTRY FROM CALL LIST

1. Open the call list.
2. Tap the detail arrow .
3. Tap  to put name and number in the internal phone book. If the name is not shown, the number will be used in its place.
4. Tap  again to open edit mode and show details buttons on screen. Continue as described below, "Editing existing entry" on page 38, paragraph 5.



ADDING CURRENT CALLER

Tap  to put name and number in the internal phone book. If the name is not shown, the number will be used in its place. To add more data, continue as described below, "Editing existing entry" on page 38, paragraph 5.



SORTING ENTRIES

Tap . Select criterion for sorting by tapping the button (first name, last name, organization, etc.).

EDITING EXISTING ENTRY

1. Tap  to open the phone's directory.
2. Scroll to entry.
3. Tap arrow button  of entry to be edited.
4. If the entry has at least two associated phone numbers, tap the name button if you wish to edit basic information or one of the number buttons if











you wish to edit information associated with that number.

5. Tap  to show details buttons on screen. Tap the button of the detail to be edited.
 - a. In some cases, a succession of text fields will open. Edit the data, if necessary, and tap the field or press  to save and to open the next text field.
 - b. In other cases, you will see a succession of screens with touch buttons. Example: "group" button with the data "favorite", group "work", contact type "VIP". 

Tap the button to open "favorite" > "group" > "contact type" one after the other. The currently selected button is marked with an asterisk. Tap the button of your choice, even when are keeping your current selection, to save and go on to the next screen.

MERGING TWO ENTRIES

1. Tap  to open the phone's directory.
2. Navigate to the entry you want to make a subentry of another directory entry. Example: "J. Merge, home 1234567" will become a subentry of "Jane Merge, office 2345678".

? Directory					
Name:	Number:	Contact Type:	Outgoing Identity:	Edit	Delete
J. Merge, home	1234567	None			
Jane Doe					
- home	5552091	VIP	Active		
- mobile	4442091	VIP	Active		
Jane Merge, office	2345678	None			

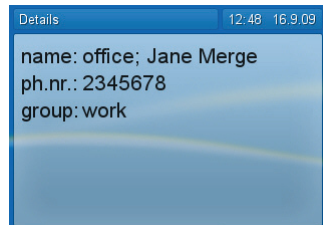
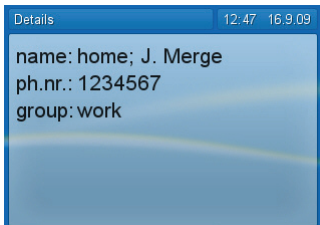

3. Tap the future subentry's button with your fingertip. The button turns yellow and the "merge" button  is activated.



4. Slide your finger from the entry button to the merge button without lifting it off the touchscreen. Another directory screen opens.
5. Navigate to the entry the subentry is to be associated with and tap the button to merge the two entries.

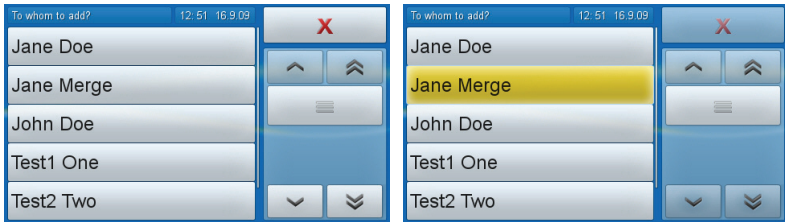

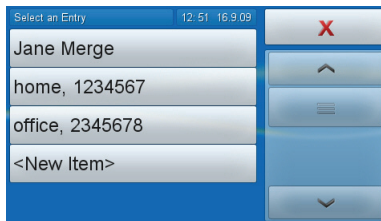

6. There is now a main entry "Jane Merge" with two subentries, "home" and "office".



? Directory				
Name:	Number:	Contact Type:	Outgoing Identity:	Edit Delete
Jane Doe				[Edit] [Delete] [More]
- home	5552091	VIP	Active	[Edit] [Delete] [More]
- mobile	4442091	VIP	Active	[Edit] [Delete] [More]
Jane Merge				[Edit] [Delete] [More]
- home	1234567	None	Active	[Edit] [Delete] [More]
- office	2345678	None	Active	[Edit] [Delete] [More]

DELETING AN ENTRY

1. Tap  to open the phone's directory.

2. Navigate to the entry.
3. Tap arrow button  of entry to be deleted.
 - a. If a name has more than one phone number associated with it, tap the name button if you wish to delete the entire group.
 - b. If you wish to delete an associated number, tap the number button.
4. Tap  to delete .

Adding/Editing Entry on Web Interface

Click on Directory in the menu on the left side.

ADDING NEW ENTRY

Type data in text fields of "Add or Edit Entry".

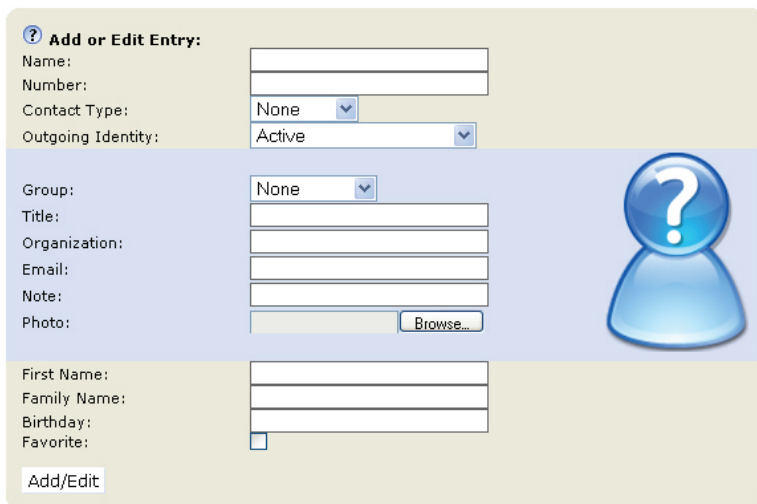

? Add or Edit Entry:

Name:

Number:

Contact Type:

Outgoing Identity:

Group:

Title:

Organization:

Email:

Note:

Photo:

First Name:

Family Name:

Birthday:

Favorite:

1. Name: Enter type of connection, i.e., home, office, mobile, etc.
2. Number: Type the number exactly as you would dial it, with country and area codes, if necessary, and without parentheses, hyphens, blank spaces.
3. Contact Type: Select from the drop-down list. The default setting is "None".
 - You can assign a distinct ringtone to the contact type "VIP": Preferences > Directory Ringtones.
 - Calls from entries on the "VIP" list will always ring on the phone, even

- when the phone is in a call or in DND mode.
 - Calls from entries on the "Deny" list will not ring on the phone, the caller will always receive a busy signal.
- 4. **Outgoing Identity:** The drop-down list shows all identities configured on the phone. If you select one of the identities for one of the numbers listed in the phone book, all calls to that number initiated from the phone book will show that identity on the callee's phone.
- 5. **Blue area:** The data entered in the textfields will be displayed when the entry is opened on the phone. They can be used to sort entries by group, name, organization, etc., and can be edited on the phone.
- 6. You can assign distinct ringtones to the group types "Friends", "Family", "Colleagues", and "Work": Preferences > Directory Ringtones.
- 7. **First name, family (last) name:** Will be added in this order under "Name" in the directory.
- 8. **Birthday.** Uses the format set at Preferences > General information > U.S. Date Format (mm/dd): "On" or "Off". Enter in DD.MM.YR or MM/DD/YR format. Examples:

		US Date Format setting	
		On	Off
March 5, 1980	5.3.80 or 3/5/80	3/5/80	5.3.80
March 12, 1980	12.3.80 or 3/12/80	3/12/80	12.3.80
October 5, 1980	5.10.80 or 10/5/80	10/5/80	5.10.80
October 12, 980	12.10.80 or 10/12/80	10/12/80	12.10.80

- 9. **Favorite:** Tick box to add entry to "Favorites" list.
- 10. Click on "Add/Edit" to save new entry to directory.

? **Directory**



Name:	Number:	Contact Type:	Outgoing Identity:	Edit	Delete
Jane Doe, mobile	4442091	VIP			
John Doe					
- home	5552090	VIP	Active		
- mobile	4442090	VIP	Active		
- office	5551234	VIP	Active		

EDITING AN ENTRY











Click on  to display current information in the text fields of "Add or Edit Entry". Two additional buttons, "Add Sub" and "Change", are now available.



1. Editing text fields.

- a. If single entry, click on  in the entry's line.
- b. If there is more than one number associated with a name:
 - Click on  in name's line if you wish to edit the master record.
 - Click on  in a phone number's line if you wish to edit subentry data.
- c. Make changes as necessary and click on "Change".

2. Adding additional phone number (subentry) for a name.

? Directory					
Name:	Number:	Contact Type:	Outgoing Identity:	Edit	Delete
Jane Doe, mobile	4442091	VIP			
John Doe					
- home	5552090	VIP	Active		
- mobile	4442090	VIP	Active		
- office	5551234	VIP	Active		

- a. Jane Doe's entry has only one phone number, her mobile phone number. In this example Jane Doe's home phone number will be added to the directory.
 - Click on  in Jane Doe's line. The data is shown in "Add or Edit" area.

? Add or Edit Entry:

Name:

Number:

Contact Type:

Outgoing Identity:

Group:

Title:

Organization:

Email:

Note:

Photo:

First Name:

Family Name:

Birthday:

Favorite:



- In the text field of "Name", delete "mobile" and type "home".
 - In the text field of "Number", delete the mobile number and enter the home phone number.
 - If you wish, select a contact type and an outgoing identity from drop-down lists.
 - Click on "Add Sub".
- b. John Doe's entry lists three phone numbers. In this example a fourth number will be added.
- Click on  in the line containing John Doe's name. The data is shown in "Add or Edit" area.

? Add or Edit Entry:

Name:

Number:

Contact Type:

Outgoing Identity:

Group:

Title:

Organization:

Email:

Note:

Photo:



First Name:

Family Name:

Birthday:

Favorite:

- Enter the new type of phone in text field of "Name", for example "mobile Japan".
 - Enter the phone number in the text field of "Number".
 - If you wish, select a contact type and an outgoing identity from drop-down lists.
 - Click on "Add Sub".
- c. The directory now contains Jane Doe's home phone number and John Doe's Japanese mobile phone number.

? Directory

Name:	Number:	Contact Type:	Outgoing Identity:	Edit	Delete
Jane Doe					
- mobile	4442091	VIP	Active		
- home	5552091	VIP	Active		
John Doe					
- home	5552090	VIP	Active		
- mobile	4442090	VIP	Active		
- office	5551234	VIP	Active		
- mobile Japan	008110945552090	VIP	Active		

DELETING ENTRY ON WEB INTERFACE

- Click on  in the line of the master record to delete the name and all associated phone numbers.

- Click on  in the line of a phone number subentry to delete that subentry, but keeping the master record and the other subentries.

Dialing from phone directory

To dial, click on  in the line of the phone number.

Deleting whole directory

Deletes entire directory irretrievably!

Importing/Exporting Directory

See our Wiki at http://wiki.snom.com/Web_Interface/V7/Directory.

EXTERNAL DIRECTORIES

Provided by your network, your VoIP provider, or another external source. Tap  to open.

LDAP

Enter the necessary data received from your administrator, VoIP provider or other external source in the text fields of the phone's web interface > Advanced > Network > LDAP and click on "Save".

Enter first letter of name you are searching for. Type more letters if name shown isn't the right one, or scroll through list. Tap name button to dial.

Contacts

On the phone's web interface > Configuration Identity # > "SIP" tab > "Contact list" click on the radio button "on". Enter the URI received from your administrator, VoIP provider or other external source in the text field of "Contact list URI" and click on "Save".

Enter first letter of name you are searching for. Type more letters if name shown isn't the right one, or scroll through list. Tap name button to dial.

USING THE PHONE

This section describes the functions of the phone with the factory default settings. If your phone was installed and/or set up by someone else, the default settings may have been changed. Please check with that person or company if the phone does not react as described here.

The caller information displayed on the screen is controlled by the setting on the phone's web interface > Preferences > General Information > Number Display Style > drop-down list (full contact, name, number, name and number, number and name). The default setting is "Name".

MAKING CALLS

See "Entering Letters, Numerals, and Special Characters" on page 16 for input modes and entering letters, numerals, and special characters. Selecting an identity for outgoing calls: See "Outgoing identities" on page 22. See "Identities/Accounts" on page 65 on how to configure identities.

Selecting Identity for Current Outgoing Call

If more than one identity is shown on the display, the one with the checkmark is the outgoing identity for the call and the number/name that will show on the callee's phone. Select a different identity by Tapping the identity's button.

Note: See "Outgoing Identities" on page 42 on how to assign a fixed outgoing identity to calls being made to a certain number. The outgoing number will only be used automatically when the call is initiated from the phone book!

Using Different Audio Devices

From the idle screen pressing a key on the alphanumeric keypad opens the "Enter number" screen with the text field in numeral input mode.

HANDSET

- Pick up handset, enter number, and tap context area or press ✓.
- or enter number and pick up handset.

HEADSET



1. Press  to switch to headset mode.

2. Enter number and tap context area or press .

SPEAKERPHONE

Enter number and press .





SPEAKERPHONE AND HANDSET OR HEADSET

1. Use dialing method for handset or headset.
2. Tap  to add speakerphone. Tap  to turn off speakerphone.



Using Auto Dial

A timespan in seconds must be selected from the drop-down menu of Advanced > Behavior > Phone Behavior > Auto Dial. The phone will dial the number on the display when the specified number of seconds has passed.

Calling Number from Call List

1. Tap , , or .
2. The last call missed, received, or dialed is at the top of the respective list. If necessary, use   to show next/previous "page" of calls.
3. To call, tap button of number.

Calling Number from Directory

1. Tap , , or .
2. Use navigation arrows to scroll through list. Alternative: Enter first letter of name and type more letters if name shown isn't the right one.
3. Tap name button to dial.

If there is more than one number associated with a name, another screen will open with the associated numbers. Tap the button of the number to be dialed.

Speed Dial

See "Speed Dial" on page 74 on setting speed dial numbers. See page 63 on mapping a speed dial number onto one of the programmable virtual function keys 1-15.

SPEED DIAL NUMBER ON SPEED DIAL LIST

1. Enter the speed dial number (0-30) or character (#, *) assigned to the phone number.
2. Tap text field or press ✓ to dial.

SPEED DIAL NUMBER MAPPED ONTO VIRTUAL KEY 1-15

1. Tap . Virtual key screen opens.



2. Tap virtual key to dial. In above example tap on key 14 to call Aunt Jane.

Emergency Numbers

Can be dialled even when the keyboard is locked! See "Emergency Numbers" on page 70 on how to set them.

1. Enter the number.
2. The phone begins to dial as soon as one of the specified emergency numbers is complete. When the keyboard is not locked, touch the text field or press ✓ to dial.

Call Completion

Depends on availability in your network. On snom phones call completion means that when a called number is busy or not available, the phone will call you back as soon as the dialed number is unbusy or available again. The factory default setting is "off".

Changing the setting to turn it on: See "Call completion" on page 71.

When call completion is available and turned on, the button  will appear below the context area.



Tap **CC** to activate call completion.



You can now dial another number, receive calls, or hang up the handset to return to the idle screen. Call completion will not interfere with the normal operation of your phone. When the number called is no longer busy or unavailable, your phone will ask whether to dial or not.

1. Display when phone is idle: Tap "OK" to dial, tap "Cancel" to terminate call completion for this call.

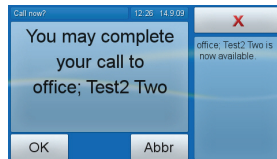

2. When in call: Tap red button to put current call on hold and dial the previously busy number.

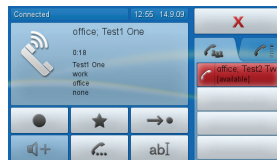

Redial

From the idle screen:

Press  to show the last 100 dialed numbers on the display. See "Call Lists" on page 20 for navigation, selection, and dialing calls from list of dialed calls.



Number Guessing (Auto Completion)

The default setting is "on". Turning it off: See "Number Guessing" on page 73 .

When you dial and have typed the minimum number of digits, the phone offers numbers containing the typed string from its call lists and from the directory for selection. Example: The setting is 4 digits. As soon as you have typed four digits, the phone offers the numbers containing that string, if any.

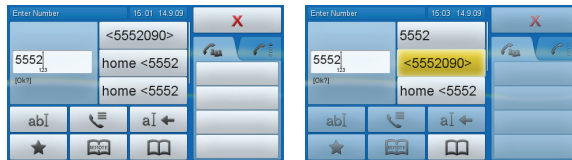

If one of the numbers offered is the number you wish to dial, tap the button. If it is not, keep entering the number.

ACCEPTING CALLS

Default settings: Incoming calls are indicated acoustically by the ringer and visually by the display icon of the contact, if available, or the symbol of a bell ringing on the display (see "Display symbols" on page 34) and the call LED blinking rapidly.

Manually



USING THE HANDSET

Pick up the handset.

USING A HEADSET

Tap the context area showing call ringing or press ✓.



USING SPEAKERPHONE AND HANDSET OR HEADSET.

1. Accept the call with the handset or the headset.
2. Tap  to add speakerphone. Tap  to turn off speakerphone.

Automatically

The default is "off". Changing the setting: See "Automatic acceptance of incoming calls" on page 66.

MISSED CALLS

Missed calls are indicated by the lit call LED and by the number of missed calls in the upper right corner of the missed call list icon . Press  to turn both indicators off.

CALL PICK-UP FROM ANOTHER EXTENSION

Must be supported by the PBX. Setting: See "Extension monitoring and call pick-up" on page 61. When there is activity on a monitored extension your idle screen will be replaced by the virtual keys screen:

1. Call ringing indicated by the green key. If the call is not answered, tap the green key to pick it up.

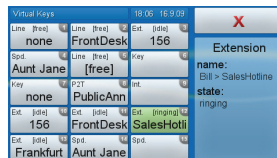

2. Monitored extension is in call: Indicated by the yellow key.

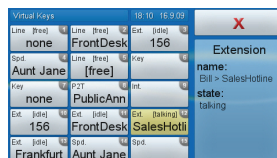

ACTIVE CALLS

Mute/unmute and volume control: See "Mute Key" on page 14 and "Volume Keys" on page 14.



ACTIVE CALLS

Mute/unmute and volume control: See "Mute Key" on page 14 and "Volume Keys" on page 14.

Hold

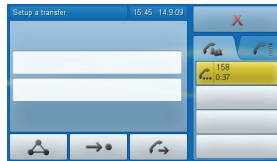
1. Press  to put current call on hold or drag-and-drop call from context area into info area.



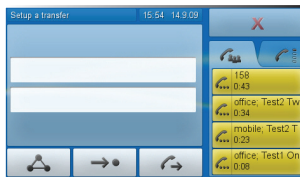

2. When a call is on hold, the call LED is blinking slowly. The symbol  in the info area indicates the line where the call is being held.
3. Press  again or drag-and-drop the button into the context area to get the caller back on the line.
4. With a call on hold you can accept and make other calls and place them on hold.





5. To get a call back on the line, tap the button where it is being held.

Conference

Maximum number of participants: 5 (your phone + 4 others)

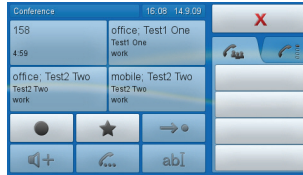
1. Put the intended participants on hold - see "Hold" on page 53.
2. Drag-and-drop the call button of each intended participant into the context area.
3. Tap  to start the conference. Tap  to turn on the casing speaker, if needed.





4. Drag-and-drop the call from the context area into the info area to remove a participant from the conference. Press  or  to put all participants on hold.



Attended and Blind Transfer

When you have a call on the line, there are two ways to transfer the call to a third party.

ATTENDED TRANSFER.

1. Put the call on hold - see "Hold" on page 53.
2. Dial the number you wish to transfer the call to and announce the call.
3. If the party wishes to accept the call, tap .
4. Drag-and-drop the held call into the text field.
5. Tap the text field or press  to transfer.

BLIND TRANSFER

1. Tap .
2. Type the number you wish to transfer the call to into the text field.
3. Tap the text field or press .

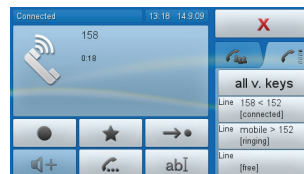
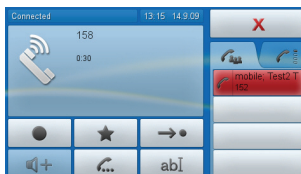

Call Waiting

The default setting is "on", which means that waiting calls are announced by a double beep and by the caller information being shown on a red button in the info area.



Changing the setting (visual only, ringer only, turn call waiting off): See "Call waiting" on page 72.

- Reject the call: Tap the red button. Button turns yellow. Drag it onto the **X** button. The caller hears the "busy" signal.
- Reject the call and place caller on DENY list (see "Contact Types" on page 35): This is not a standard setting; change at Advanced > Behavior > Deny all feature > "On".

When the feature is available, the escape area will show  in addition to **X** when you tap the call button (button turns yellow). Drag it onto  without lifting your finger off the display. The caller hears the busy signal and is placed on the Deny list.

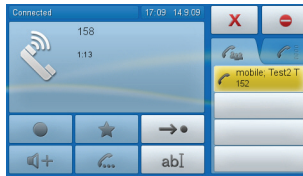

- Accept the call: Tap the red call button to accept the second call. The first call is put on hold.

TERMINATING CALLS

1. When using the handset alone: Hang up handset or tap or press **X**.
2. In all other cases: Tap or press **X**.

REJECTING OR REDIRECTING INCOMING CALLS

This includes manual and automatic rejection and redirection as well as the rejection of anonymous calls.

Manually



If you do not wish to pick up a ringing call, you can obviously let it ring, reject it, or blindly transfer it:

REJECT

- Tap or press **X**. The caller hears the "busy" signal.
- Tap the  button to reject the call and place the caller on the DENY list (see "Contact Types" on page 35). The caller hears the busy signal.





This is not a factory setting. Changing the setting: Advanced > Behavior > Deny all feature > "On".

REDIRECT (BLIND TRANSFER)

Tap  > type the phone number you want to transfer the call to into the text field > tap the text field or press . The incoming call will start to ring on the other phone.



Automatically

Options for automatic rejection or forwarding of incoming calls:

- Deny List. See "Contact Types" on page 35.
- DND (do not disturb mode). Callers hear the busy signal. Tap  or press  to activate. Tap  or press  again to turn DND off.
- Call Forwarding. See page 70.

Rejecting anonymous calls

Please note that calls from analog phone connections without caller ID will, most likely, be received as anonymous calls and rejected if you turn this function on.

 or  > 2 Call Features > 3 Incoming Calls > 2 Reject anonymous > "On". Tap  to return to idle screen.

CALL FORWARDING







Forward All: Forwarding all incoming calls to the number of the phone, extension, or mailbox specified as this function's target.

Forward when Busy: Forwarding calls ringing while phone is busy to the number of the phone, extension, or mailbox specified as this function's target.

Forward after Timeout: When a call starts ringing, the phone will wait for the number of seconds specified. If the call is not accepted by the end of this time period, it is forwarded to the number of the phone, extension, or mailbox specified as this function's target.







Making/changing settings on the phone









Setting phone numbers: See the following table. Tapping the text field or pressing ✓ after typing the number saves the setting and returns the display to the previous screen.

	Forward all	Forward when busy	Forward after timeout
Tap	 or press 	 or press 	 or press 
Tap	2 Call Features	2 Call Features	2 Call Features
Tap	1 Call Forwarding	1 Call Forwarding	1 Call Forwarding
Tap	1 Forward All	2 Forward when Busy	3 Forward after Timeout
Tap	2 Target when forwarding	2 Target when forwarding	2 Target when forwarding
Type	phone number	phone number	phone number
Tap	text field or press ✓	text field or press ✓	text field or press ✓
Tap			3 Call Forwarding time
Type			number of seconds
Tap			text field or press ✓
Tap	 to return to idle screen or		
	turn on call forwarding		





Turning on call forwarding

If the phone number has not been set or needs to be changed, follow instructions from top of table. If the phone number has been set, skip the gray-shaded area.

	Forward all	Forward when busy	Forward after timeout
Tap	 or press 	 or press 	 or press 
Tap	2 Call Features	2 Call Features	2 Call Features
Tap	2 Call Forwarding	2 Call Forwarding	2 Call Forwarding
Tap	1 Forward All	2 Forward when Busy	3 Forward after Timeout

Tap	2 Target when Forwarding	2 Target when Forwarding	2 Target when Forwarding
Type	phone number	phone number	phone number
Tap	text field or press 	text field or press 	text field or press 
Tap	 to return to idle screen		3 Call Forwarding time
Type			number of seconds
Tap			text field or press 
Tap		1 Enable Forwarding	1 Enable Forwarding
Tap		Yes button	Yes button
Tap		 to return to idle screen	 to return to idle screen
	The idle screen now shows the "call forward active" icon and the target phone number. 	No change on idle screen	No change on idle screen

Turning off call forwarding

- Forward all: Tap .
- Forward when busy:
 -  > 2 Call Features > 1 Call Forwarding > 2 Forward when Busy > 1 Enable Forwarding > No >  to return to idle screen
- Forward after timeout.
 -  > 2 Call Features > 1 Call Forwarding > 3 Forward after Timeout > 1 Enable Forwarding > No >  to return to idle screen

CONFIGURING THE FUNCTION KEYS

See "The Phone's Web Interface" on page 26 on how to open the phone's web interface, "User Mode/Administrator Mode" on page 29 for an explanation of administrator and user mode. See "How the Web Interface Works" on page 28 on the mechanics of navigating in the windows and changing the settings.

Any changes you make will not take effect until you press "Save". Changes will be lost if you open another page of the web interface without first pressing "Save".

Every phone has a limited number of hard keys. Phone users, however, have a myriad of different priorities and preferences when asked which functions they use most often and which functionalities they would like to access quickly. snom has therefore designed the function keys to be programmable, even the preprogrammed "hard keys" whose default function is printed on the casing. And we have made it easy to customize the settings to your needs and preferences as we'll demonstrate here with programming a virtual function key for extension monitoring/call pickup and speed dialing.

FREELY PROGRAMMABLE VIRTUAL FUNCTION KEYS

The snom 870 has 15 virtual function keys. On the phone they are called "virtual keys" or "v.keys". The numbers in the upper right corner correspond to the numbers on the phone's web interface > Function keys , P1 - P15 (P = programmable).

Type	Number	Short Text	
Line			P1
Speed Dial			P2
Line			P3
Line			P4
Line			P5
Line			P6
Key Event	None		P7
Push2Talk	< sip:225@	PublicAnnouncement	P8
Intercom			P9
Extension	< sip:156@		P10
Extension	< sip:124@	FrontDesk	P11
Extension	< sip:151@	SalesHotline	P12
Extension	< sip:158@	FrankfurtOffice	P13
Speed Dial	159	Aunt Jane	P14
Speed Dial			P15

Context	Type	Number	Short Text	
Active	Line			P1
Active	Extension	< sip:124@	FrontDesk	P2
Active	Extension	< sip:156@		P3
Active	Speed Dial	5552091	Aunt Jane	P4



1. The text in the upper left corner of the phone's v.key indicates the type of functionality mapped onto the key.

The factory default is "line". Incoming and outgoing calls will use any available line unless you enter a phone line under "Number". If you do, all calls arriving on that line will go to that key. To make calls using that line, tap the virtual key and enter the number to be dialed in the text field.

2. The text or number in the main section is the text you entered on the web interface in the text field under "Short Text". If the text field is empty, it is the number entered under "Number".

3. Settings.

Context	Type	Number	Short Text	
Active	Line			P1
Active	Line	< sip:124@	FrontDesk	P2
Active	Shared Line	< sip:156@		P3
Active	Extension	5552091	Aunt Jane	P4
Active	Park+Orbit			P5
Active	Voice+Recorder			P6
Active	DTMF			P7
Active	Push2Talk			P8
Active	Intercom	None		P9
Active	Action URL	< sip:225@	PublicAnnouncement	P10
Active	Key Event			P11
Active	Speed Dial			P12
Active	Button	< sip:156@		P13
Active	Presence	< sip:124@	FrontDesk	P14
Active	BLF	< sip:151@	SalesHotline	P15
Active	IVR	< sip:158@	FrankfurtOffice	P16
Active	Transfer to	159	Aunt Jane	P17
Active	Forward to			P18
154@	Auto Answer			P19
	Call Agent			P20
	None			P21

- a. Context. Select "Active" or one of the configured identities from the drop-down list. "Active" means the identity selected as the outgoing identity at any one time.
- b. Type. Select the type of functionality from the drop-down list. See

snom's WIKI for more information. If you select "Key Event", click on "Save" to open the drop-down list with the available key events under "Number".

- c. Number. Enter the phone number or value for the function or, if key event, select item from drop-down list.
- d. Short Text. Optional. See also paragraph 2 on page 60.

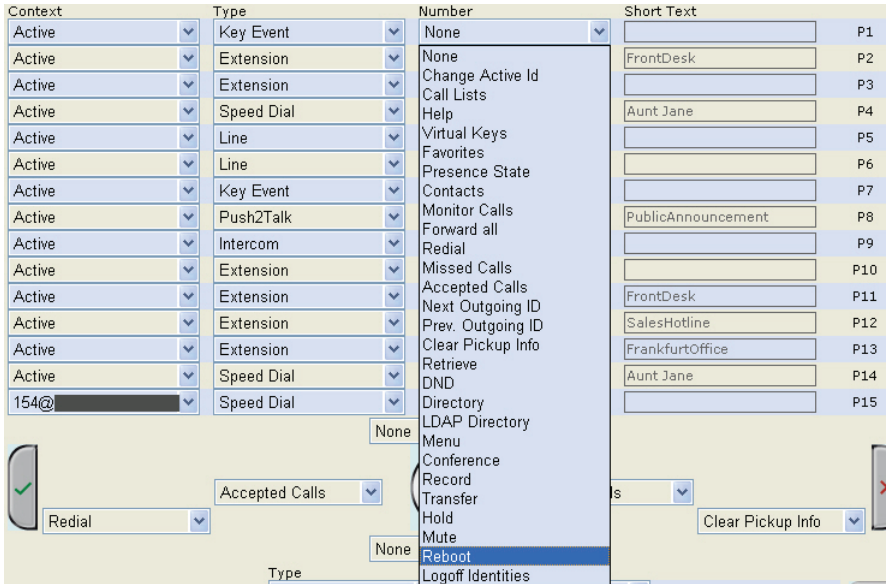

Extension monitoring and call pick-up

Must be supported by your PBX!

This feature makes it possible to pick up a call ringing on another extension. One of the freely programmable virtual function keys must be dedicated to “watching” that extension. In our example we are watching the key named P12 on the web interface, the number for the Sales Hotline.

Type	Number	Short Text	
Line			P1
Extension	< sip:158@	FrontDesk	P11
Extension	< sip:151@	SalesHotline	P12
Extension	< sip:156@	FrankfurtOffice	P13

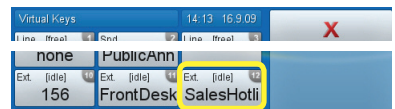

1. Phone's web interface > Function Keys.
2. Under "Type", select "Extension" from the drop-down list of P12.
3. Under "Number", enter the extension/phone number whose calls you wish to pick up. In our example it is extension 151.
4. The "Short Text" is optional. If you enter text, it will be shown on the phone's virtual key.

Whenever there is activity on the extension (ringing, off hook, in call), the display of your phone will switch from idle screen to the "Virtual Keys" screen. The key is green when the phone is ringing; tap it to pick up the call. When the key is yellow, the extension is in a call.

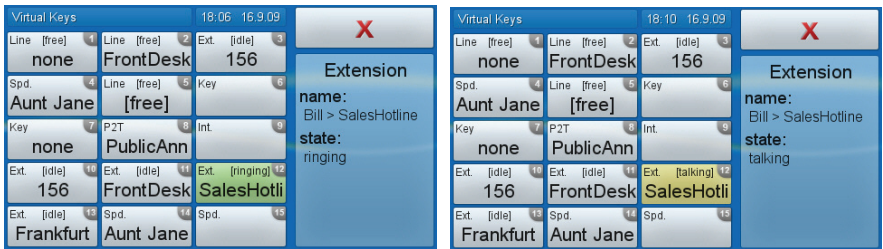

MONITORED CALLS SCREEN

Tap . The activity on the monitored extensions is shown:

- White button: In call.
- Green button: Incoming call ringing on monitored extension. Call pickup: Tap the button.

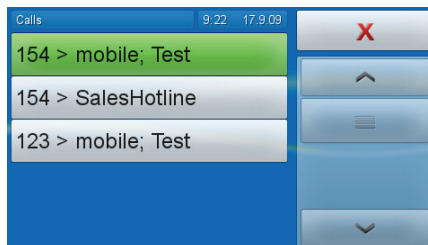

Mapping speed dial number onto virtual function key

Example: Dialing Aunt Jane's phone number by tapping virtual key 14 (P14).

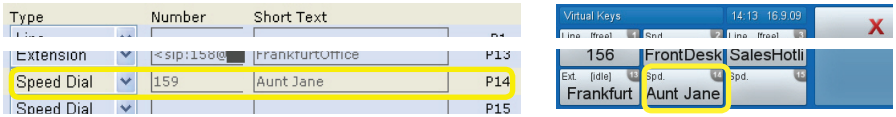

1. Under "Type", select "Speed" from the drop-down list of P14.
2. Under "Number", enter Aunt Jane's phone number exactly as you would dial it, i.e., with country and area code, if applicable, and without hyphens, parentheses, or empty spaces.
3. The "Short Text" is optional. If you do not enter text ("Aunt Jane", for example), the phone number will be shown on the virtual key
4. Click on "Save".

Speed dialing Aunt Jane's phone number:  > 

VARIABLE FUNCTION KEYS

Navigation keys

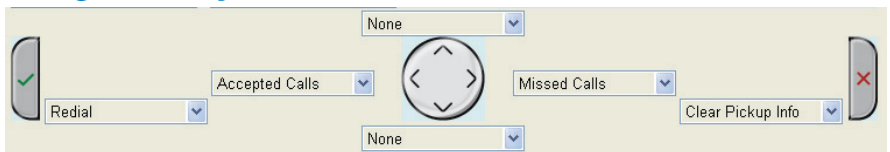







Factory settings for navigation keys when screen is idle - see page 13. Other key events can be mapped onto the navigation keys, but these events are also available only when the phone is idle.

Preprogrammed, variably programmable function keys

The factory settings are printed on the casing - see page 14. Mapping another functionality onto one of the keys:

1. Select one from the drop-down list of "Type" and enter the number of type in the text field under "Number".
2. If the type is "Key Event", another drop-down list is available for selection under "Number".
3. Click on "Save".

Type	Number	
Key Event	Retrieve	Retrieve 
Key Event	DND	DND 
Key Event	Directory	Directory 
Key Event	Menu	Menu 
Key Event	Transfer	Transfer 
Key Event	Hold	Hold 
Voice Recorder		
DTMF		
Action URL		
Key Event		
Speed Dial		
Button		
IVR		
Transfer to		
Forward to		
Auto Answer		
None		

CUSTOMIZING PHONE SETTINGS

See "The Phone's Web Interface" on page 26 on how to open the phone's web interface, how the web interface works, on how to change the settings, and what the difference between administrator and user mode is.

If you have access to administrator mode, but do not consider yourself to be an expert on SIP and SIP phones, we recommend that you do not change any of the technical settings since this may adversely affect the phone's performance or put it out of order altogether.

If you want more information on a web interface setting, click on the button with the question mark that you see to the right of each item. It links to a page on snom's Wiki with detailed information about that particular item.

Any changes you make on the web interface will not take effect until you click on **Save**. Changes will be lost if you open another page of the web interface without first clicking on **Save**.

IDENTITIES/ACCOUNTS

The phone supports up to twelve accounts or "phone numbers" with one or more providers or within an office or organization network. On snom phones these accounts or phone numbers are called "identities".

If your phone is part of an office network, you may need to contact your administrator to configure new or change existing identities, as this can only be done when the phone is running in administrator mode.

See "Phone Installation and initialization" on page 8 for the information on required input data.

Configuring New Identity/Account

ON THE PHONE

Basic setup (account/number & registrar) only:

Settings > 3 Identity > 3 Edit User > tap on an empty button > enter Account > enter Registrar.

ON THE WEB INTERFACE

Click on an identity in the menu on the left. The configuration window for that

identity will open; it contains four tabs, with the left one, Login, visible in the front.

Enter the information received from your provider or your administrator in the appropriate fields.

- The display name is optional and freely selectable. It will be sent to any parties you call unless you hide your identity (see "Hide own Identity" on page 73). If you do not enter a display name, the data in the "Account" text field will be shown on your display and sent to any parties you call unless you hide your identity.
- Any text you enter in "Display text for idle screen" will be shown - instead of your display name or account - **on your display only**. It will not be sent to any parties you call.
- You can choose one of 10 built-in ringtones or a custom melody, or turn off the ringer by selecting "Silent".



Select a ringer from the ringtone drop-down list of Login > Ringtone and click on "Play Ringer". The tone will be played by your phone.

If you have selected the custom melody, enter the URL to the data file in the text field underneath. It must be a file of the type PCM 8 kHz 16 bit/sample (linear) mono WAV.

Click on "Re-Register" and "Save".

Please note: The ringer set for a contact type overrides the ringer for a particular identity; in case of a conflict the phone will use the contact type ringer. If your ringtones don't seem to work as expected, contact your administrator. There may be an overriding setting on the PBX.

Automatic acceptance of incoming calls

1. Setting: Identity # > SIP tab > Auto Answer  > Save
2. Select audio device (handsfree, handset, headset) for automatic acceptance: Preferences > Auto Answer > Type of Answering > pull-down list > Save
3. If you wish to be alerted acoustically whenever the phone accepts a call automatically: Preferences > Auto Answer > Auto Answer Indication 

Contact List

A contact list must be available on a server. Setting:

1. Identity (1-12) > SIP tab > Contact List > .
2. Contact List URI > enter URI in text field.
3. Click on "Save".

Editing an Existing Identity/Account

ON THE PHONE

Editing of account/number & registrar only!

1. Tap  > 3 Identity > 3 Edit User > tap button of identity you wish to change.
2. Edit account number, if applicable > touch text field or press ✓.
3. Edit registrar, if applicable > touch text field or press ✓ to reregister identity and return to idle screen.

ON THE WEB INTERFACE

Open the Configuration Identity (1-12) page of the identity and make the changes in the text fields. See "Configuring New Identity/Account" on page 65.

If you have changed the account or the registrar, click on "Re-Register". If you have made other changes, clicking on "Save" suffices.



LANGUAGE SETTINGS OF PHONE AND WEB INTERFACE

The language used on the phone can be changed on the phone as well as on the web interface. The language used on the web interface can be changed on the web interface only.

Phone Language

SETTING ON THE PHONE.

1.  > 1 Preferences > 1 Language > if necessary, use arrow buttons to scroll one screen up/down at a time or scrolling with a fingertip - see „Using the Touchscreen“, paragraph 3 on page 18.

2. Select a language by tapping its button.
3. Tap  to return to previous screen, tap  to return to idle screen.

SETTING ON THE WEB INTERFACE.

Preferences > General Information > Language > select from drop-down list > Click on "Save".



Web Interface Language

Preferences > General Information > Webinterface language > select from drop-down list > "Save".

DIAL TONES

Different dial tones for different countries! Select yours on the phone or on the web interface.

On the Phone

1.  > 1 Preferences > 3 Tone Scheme > if necessary, use arrow buttons to scroll one screen up/down at a time or scroll with the fingertip - see "Using the Touchscreen" paragraph 3, on page 18.
2. Select a country by tapping its button.
1. Tap  to return to previous screen, tap  to return to idle screen









On the Web Interface

Preferences > General Information > Tone Scheme > select country from drop-down list > "Save".

TIME ZONE

The list is arranged by the difference in hours (+/-0) to the UTC and, within each time zone, alphabetically by selected locations. The setting can be changed on the phone and on the web interface (administrator mode only).

On the Phone

1.  > 1 Preferences > 2 Time Zone
2. Navigation.
 - a. Scrolling.
 - Tap  /  to move to beginning of next timezone/ beginning of preceding timezone.
 - Tap  /  to move one screen up/down at a time.
 - Scroll with a fingertip - see "Using the Touchscreen", paragraph 3, on page 18.
 - b. Tap  to contract the list of time zones to show only those entries where your selected phone language is spoken, tap  to show all time zones.
3. Select a country/city by tapping its button.
4. Tap  to return to previous screen, tap  to return to idle screen.

On the Web Interface

Available in administrator mode only.



Advanced > Network tab > Time > Timezone > select your country (city) in the drop-down list > "Save".

DATE AND TIME FORMATS

Can be set and changed on the web interface only.

Date



Preferences > General Information > US Date Format

 on	Formats:	m/d (example: 5/6 means May 5) mm/dd (example: 10/12 means October 12)
 off	Formats:	d.m (example: 6.5 means May 5) dd.mm (example: 12.10 means October 12)

Time

The time setting affects phones and/or firmware versions with a digital clock only. If the phone has a clock face, changing the setting will not affect it.

Web interface > Preferences > General Information > 24 Hour Clock

 on	The time on the phone's display will be shown in 24-hour format, 00:01 to 24:00
 off	The time on the phone's display will be shown in AM/PM format, 0:01 AM to 12:00 PM.

EMERGENCY NUMBERS

These are numbers that can be dialed even when the keyboard is locked. They must be set beforehand on the web interface.

- Click on Preferences > Lock Keyboard > Emergency Numbers (space separated).
- Enter the emergency numbers in the text field. Type each number without spaces between the digits, separate the individual numbers with one empty space between them.

Example: If you want to set the emergency phone number 911 and the phone numbers of your doctor (986543) and a friend (234578), the entry would look this: 911 986543 234578.

- Click on .

CALL FORWARDING

This feature automatically redirects all or certain incoming calls to another phone or a mailbox. It is possible to configure the settings on the phone and on the web interface.

Always. All incoming calls are forwarded to the number of the phone, extension, or mailbox specified as this function's target.

Busy. Calls ringing while phone is busy are forwarded to the number of the phone, extension, or mailbox specified as this function's target.

Timeout. When a call starts ringing, the phone will wait for the number of seconds specified. If the call is not accepted by the end of this time period, it is forwarded to the number of the phone, extension, or mailbox specified as

this function's target.



On the Phone

See "Making/changing settings on the phone" on page 57, "Turning on call forwarding" on page 57, and "Turning off call forwarding" on page 54.

On the Webpage

If your internet telephony provider or your PBX uses codes to turn functions on and off, refer to their manuals for the codes to enter in "On Code"/"Off Code" text fields or ask your administrator.

SETTING FORWARDING NUMBERS

- Always (all incoming calls): Preferences > Call Forwarding > Always. Type number in "Target" text field. 
- Busy: Preferences > Call Forwarding > Busy. Type number in "Target" text field. 
- Timeout: Preferences > Call Forwarding > Timeout. Type number in "Target" text field; type number of seconds in the "Timeout (sec)" text field. 

TURNING CALL FORWARDING ON

1. Web interface > Preferences > Call Forwarding.
2. Click on "On" after the forwarding event ("Always", "Busy", "Timeout"). Click on .

TURNING CALL FORWARDING OFF

1. Web interface > Preferences > Call Forwarding.
2. Click on "Off" after the forwarding event ("Always", "Busy", "Timeout"). Click on .

CALL COMPLETION

See also "Call Completion" on page 49. The factory default setting is "off". Changing the setting to turn it on:

On the phone

1.  > 2 Call Features > 2 Outgoing Calls > 3 Call Completion
2. Tap "On" button to save and return to previous screen.

On the web interface

Open the phone's web interface > Advanced > Behavior > Phone Behavior > Call completion > .

CALL WAITING

See "Call Waiting" on page 54 on how to use this feature. The default setting is "on", which means that waiting calls are announced both acoustically and visually.

1. Acoustic announcement: Double beep.
2. Visual announcement: Caller information (default symbol or info available in contacts or directory) is shown in the info area.

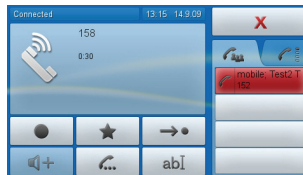

Changing the setting to "visual only", "ringer" only, or call waiting "off": Web interface > Advanced > Audio > Call Waiting Indication > select from drop-down menu > click on "Save".

RINGTONES

You can choose one of 10 built-in ringtones or a custom melody, or turn off the ringer.

- A ringtone can be assigned to an identity so that incoming calls for different identities will be announced by different ringtones. See "Configuring New Identity/Account" on page 65.
- A ringtone can also be assigned to contact types so that incoming calls from phone numbers of that type will be announced by the selected ringtone. See "Contact Types" on page 35.
- When using a headset, choose whether the ringtone will sound in the

headset or on the loudspeaker: Preferences > Ringtone Defaults > Ringer Device for Headset > drop-down list > "Save".

Note: *The ringer set for a contact type overrides the ringer for a particular identity; in case of a conflict the phone will use the contact type ringer. If your ringtones don't seem to work as expected, contact your administrator. There may be an overriding setting on the PBX.*

HIDE MY CALLER ID

With this setting your phone number will not be transmitted to any phones you call. Please note that your call may not be accepted if the other phone is set to reject anonymous calls (see next item).

Web interface > Preferences > Privacy Settings > Call Line Identification Presentation (CLIP) > radio button "Hide" >

REJECT ANONYMOUS CALLS

With this setting you will not receive calls from phones whose number is not shown on your display. Anonymous callers will hear the busy signal.

Please note that calls from analog phone connections will, most likely, be received as anonymous calls.

Web interface > Preferences > Privacy Settings > Call Line Identification Restriction (CLIR) > radio button "Reject" >

NUMBER GUESSING

When you have typed the minimum number of characters you have specified for this function, the phone will look for numbers containing that string of characters in its call lists and directories and, if it finds matches, show the number(s) on the display.

Advanced > Behavior tab > Phone Behavior.

Number Guessing Minimum Length: Type number of digits in text field.

Number Guessing: Click on radio button "on".

SPEED DIAL

You can use the numbers from 0 to 30 and the special characters # and * to dial without having to enter the complete phone number.

Open the phone's web interface > Speed Dial. Enter one phone number with any required prefixes in the text field for each respective number or special character. Examples:

Speed dial number	Type of number	Conventional notation	Entry in speed dial table
0	Emergency number	911	911
1	Local number	555-1234	5551234
2	Number with area code	(916) 555-1234	9165551234
3	Number in foreign country, dialling "00" before phone number required	+49 30 398330	004930398330

Do not add a name or other data before or after the number!

Mapping a speed dial number onto one of the virtual function keys: See page 63.

SOFTWARE UPDATE

MANUAL UPDATE

1. Open snom's web page at www.snom.com.
2. Click on Support > Download > Firmware.
3. Click on the phone to be updated.
4. Click on the firmware version currently running on your phone.
5. Click on the firmware version you want to update to.
6. Right-click on the version's link and copy it.
7. Open the phone's web interface > Software Update.
8. Paste the link into the text field behind Firmware.
9. Click on "Load". The phone begins to reboot.
10. When the phone asks "Reboot?", tap "OK".

Do not disconnect the power while the phone is rebooting!

AUTO PROVISIONING

See our web page http://wiki.snom.com/Features/Mass_Deployment for information.

Open the phone's web interface > Advanced > Update tab.

Click on the question mark  behind each line and read the instructions carefully before attempting auto provisioning!

TROUBLESHOOTING

REBOOT

Required when asked for on display, for example when a setting is changed that requires a reboot to take effect.

1. Tap  > 5 Maintenance (3 in user mode) > 3 Reboot > "OK".
2. Wait for idle screen to reappear.



HARD REBOOT

NEVER EVER PULL THE POWER PLUG WHILE THE PHONE IS DOWNLOADING FIRMWARE!

1. Pull the power plug of the phone.
2. Reconnect the phone's power after a few seconds.
3. Wait for idle screen to reappear.

RESET TO FACTORY VALUES

Please note that any customized settings will be overwritten.

1. Tap  > 5 Maintenance (3 in user mode) > 4 Reset Values.
2. Enter administrator password.
3. Press . Wait for prompt.
4. See "Initialization and registration" on page 10 to continue.

CONTACT SNOM SUPPORT

Open snom's web page at www.snom.com. Click on the Support tab to open the Support window. Click on the link to the contact form. Complete the contact form and add the required attachments in text format before clicking on "Submit". See the following paragraphs on how to prepare and enclose the attachments.

Creating and enclosing attachments

System and settings information must always be attached!

1. Open the phone's web interface > Status > System information.
2. Open a text editor, for example, Microsoft's Windows Editor. Do not use Word documents, PDFs, etc.
3. Copy the text in the gray field into the text editor.
4. Under "Status" in menu on left, click on "Settings".
5. Copy the text in the main area of the window into the text editor underneath the systems information.
6. Save the file.
7. Click on the Browse button and place the saved file's path in the text field to the left of it.
8. Click on "Submit".

SIP Trace and PCAP Trace

snom Support may need you to do a SIP Trace and/or a PCAP Trace to help them analyze your problem.

PERFORMING A SIP TRACE

1. Click on SIP Trace under Status in the menu on the left. Click on Clear to clear the page.
2. Recreate the error to be documented in the trace. Click on Reload.
3. See above for creating and attaching a text file to the support form.

PERFORMING A PCAP TRACE

1. Click on PCAP Trace under Status in the menu on the left. Click on Start to begin recording network traffic.
2. Click on Stop to end recording.
3. Click on link "here" to open file download window. Save the file.
4. See above for creating and attaching a text file to the support form.

MANUAL INITIALIZATION

When automatic initialization via DHCP fails, enter the values for netmask, IP gateway, and DNS server manually after each prompt on the display.

STANDARD CONFORMANCE

Name and address of manufacturer:

snom technology AG
Charlottenstr. 68-71
10117 Berlin
Germany

snom technology AG assures that the product

Type: VoIP phone

Model: snom 870

has been tested and found to comply with the requirements of:

- **Product Standard EN 55022 : 2006 +A1:2007**

 - EN 55024 : 1998+A1:2001+A2:2003**

Harmonic current:	EN 61000-3-2:2006 Class A
Voltage fluctuation & Flicker:	EN 61000-3-3:1995 +A1:2001+A2:2005
ESD – housing:	EN 61000-4-2:2001 ED.1.2
RF field 80–1000 MHz – housing:	EN 61000-4-3:2006+A1:2007 ED.3.0
Burst – I/O ports < 3 m:	EN 61000-4-4:2004 ED.2.0
Burst – power line:	EN 61000-4-5:2005 ED.2.0
Surge – I/O PORTS < 30 m:	EN 61000-4-6:2006 ED.2.2
RF conducted 0,15 – 80 MHz power line:	EN 61000-4-8:2001 ED.1.1
Changes of mains voltage – power line:	EN 61000-4-11:2004 ED.2.0

- **FCC Part 47 CFR Ch.1 Part 15 2008-07-10 Emission**

Section 15.107(a), limits as IEC/CISPR 22:1997 Class B

Section 15.109(g), i.e. IEC/CISPR 22:1997 Class B

ICES-003: 2004 Class B

- **UL 60950-1, 1st Edition, 2007-10-31**

(Information Technology Equipment - Safety - Part 1: General Requirements)

CSA C22.2 No. 60950-1-03, 1st Edition, 2006-07 (Information Technology Equipment - Safety - Part 1: General Requirements)

Report Reference No. E199598-A68-UL1

Berlin, 18 September 2009

Dr. Christian Stredicke
Vorstand (MD)

