



# Grandstream Networks, Inc.

---

## GVR3550 Network Video Recorder

### User Manual



## TABLE OF CONTENTS

<b>WELCOME.....</b>	<b>8</b>
SAFETY COMPLIANCES.....	9
FCC CAUTION .....	10
RF EXPOSURE INFORMATION (SAR) .....	10
WARRANTY .....	11
<b>INSTALL GVR3550 .....</b>	<b>12</b>
EQUIPMENT PACKAGE CONTENTS .....	12
CONNECTING THE GVR3550.....	13
INSTALLING HDD .....	13
SYSTEM CONNECTION.....	15
NETWORK CONNECTION .....	16
EXTERNAL USB DEVICE .....	16
PLUG IN USB MOUSE/KEYBOARD .....	17
INPUT METHOD .....	18
PLUG IN USB STORAGE DEVICE .....	19
INSTALLING eSATA .....	20
CONNECT HDMI MONITOR.....	20
CONNECT VGA MONITOR.....	20
CONNECT ALARM DEVICE .....	21
EXTERNAL INTERCOM DEVICE .....	21
<b>PRODUCT OVERVIEW .....</b>	<b>22</b>
GVR3550 SPECIFICATIONS.....	22
GVR3550 FRONT PANEL .....	24
GVR3550 BACK PANEL.....	26
IR REMOTE CONTROL .....	27
<b>LOCAL OPERATIONS .....</b>	<b>30</b>
USING THE WIZARD .....	30
LOGIN.....	30
LOCAL VIEW .....	31
VIEW STATUS .....	32
BASIC VIEW OPERATION.....	34
IMAGE CONFIG .....	36
PTZ CONTROL .....	36
PRESET .....	38
PATROL .....	39
PATTERN.....	40
RIGHT-CLICK.....	41
SHORTCUT BUTTON .....	42
LOCAL PLAYBACK .....	43
SEARCH RECORD .....	43
SEARCH BY TIME.....	43
SEARCH BY TAG .....	45
RECORD PLAYBACK .....	46
<b>MAIN MENU.....</b>	<b>49</b>
CAMERA MANAGEMENT.....	50
SEARCH/CONFIGURE CAMERA.....	50
RECORD MODE CONFIG.....	52
CAMERA EVENT SETTINGS.....	53
ENCODING CONFIG .....	55
SCHEDULE CONFIG .....	57

HOLIDAY CONFIG .....	60
ALARM CONFIG .....	62
(IO) ALARM CONFIG .....	62
ABNORMAL ALARM CONFIG .....	65
NETWORK SETTINGS .....	66
BASIC SETTINGS .....	66
ADVANCED SETTINGS .....	68
ENABLE DDNS .....	68
ENABLE UPnP .....	68
ENABLE DHCP .....	69
<b>SYSTEM SETTINGS .....</b>	<b>70</b>
BASIC SETTINGS .....	70
DATE&TIME .....	72
DISPLAY SETTINGS .....	73
EMAIL SETTINGS .....	74
LOCAL VIEW CONTROL .....	75
HDD MANAGEMENT .....	76
USER MANAGEMENT .....	79
ADDING A USER .....	80
INPUT USER INFO AND EDITING PRIVILEGE .....	80
DELETING A USER .....	82
NTP SERVER .....	83
MAINTENANCE .....	83
UPGRADE .....	83
BACKUP .....	85
QUICK BACKUP .....	86
SEARCH BACKUP .....	87
RESET & REBOOT .....	88
IMPORT & EXPORT .....	89
TROUBLESHOOTING .....	90
NETWORK DIAGNOSIS .....	90
HDD DETECTION .....	91
SYSTEM LOG .....	93
<b>STATUS .....</b>	<b>95</b>
RECORDING INFO .....	95
SYSTEM INFO .....	96
NETWORK INFO .....	97
RESOURCE USAGE .....	98
ALARM INFO .....	99
HDD INFO .....	100
LOGOUT .....	100
<b>WEB MANAGEMENT .....</b>	<b>101</b>
OVERVIEW .....	101
SYSTEM LOGIN .....	101
WEB PAGE INTRODUCTION .....	102
LIVE VIEW .....	103
PLAYBACK .....	105
SETTINGS .....	106
BASIC SYSTEM SETTINGS .....	106
DEBUG LOG .....	107
STATUS - QR CODE .....	108
<b>FIRMWARE UPDATE .....</b>	<b>109</b>

DOWNLOAD CONFIGURATION FILE .....	109
CONFIGURING SERVER .....	109
CONFIGURING TFTP SERVER.....	110
CONFIGURING HTTP SERVER .....	112
UPGRADE WITH TFTP SERVER .....	113
UPGRADE WITH HTTP/HTTPS SERVER .....	113
MANUAL UPGRADE .....	113
<b>FACTORY RESET .....</b>	<b>114</b>
RESET VIA LOCAL GUI .....	114
RESET VIA WEB PAGE .....	114
RESET VIA BUTTON .....	115
<b>EXPERIENCING GVR3550 .....</b>	<b>116</b>
<b>APPENDIX .....</b>	<b>117</b>
FAQs .....	117
RECORD TIME CALCULATION .....	120

## TABLE OF FIGURES

FIGURE 1: GVR3550 HDD INSTALLATION.....	14
FIGURE 2: GVR3550 SYSTEM CONNECTION DIAGRAM.....	15
FIGURE 3: GVR3550 “STATUS” → “NETWORK INFO” PAGE.....	16
FIGURE 4: GVR3550 SYSTEM SETTING PAGE.....	17
FIGURE 5: GVR3550 SOFT KEYBOARD – ENGLISH INPUT METHOD.....	18
FIGURE 6: GVR3550 SOFT KEYBOARD – CHINESE INPUT METHOD.....	18
FIGURE 7: GVR3550 SOFT KEYBOARD – SYMBOL AND NUMBER.....	19
FIGURE 8: GVR3550 SOFT KEYBOARD – NUMERIC KEYBOARD.....	19
FIGURE 9: GVR3550 HDD MANAGEMENT PAGE.....	20
FIGURE 10: GVR3550 FRONT PANEL.....	24
FIGURE 11: GVR3550 BACK PANEL.....	26
FIGURE 12: IR REMOTE CONTROL.....	27
FIGURE 13: GVR3550 LOCAL LOGIN PAGE.....	31
FIGURE 14: GVR3550 LIVE VIEW PAGE – RIGHT CLICK MENU.....	32
FIGURE 15: GVR3550 BASIC VIEW OPERATION.....	34
FIGURE 16: GVR3550 IMAGE CONFIG PAGE.....	36
FIGURE 17: GVR3550 PTZ CONTROL PAGE.....	36
FIGURE 18: GVR3550 PTZ CONTROL PAGE – PRESET.....	38
FIGURE 19: GVR3550 PTZ CONTROL PAGE – PATROL.....	39
FIGURE 20: GVR3550 PTZ CONTROL PAGE – PATTERN.....	40
FIGURE 21: GVR3550 RIGHT CLICK MOUSE MENU.....	41
FIGURE 22: GVR3550 VIEW PAGE SHORTCUT BUTTON MENU.....	42
FIGURE 23: GVR3550 RECORD PLAYBACK PAGE.....	43
FIGURE 24: GVR3550 RECORD PLAYBACK – RECORD STATUS TOOLBAR PAGE.....	44
FIGURE 25: GVR3550 RECORD PLAYBACK – RECORD STATUS TOOLBAR PAGE.....	45
FIGURE 26: GVR3550 TAG MANAGEMENT PAGE.....	45
FIGURE 27: GVR3550 RECORD PLAYBACK TOOLBAR.....	46
FIGURE 28: GVR3550 SAVE SNAPSHOT FAILED PROMPT.....	47
FIGURE 29: GVR3550 TAGGING MANAGEMENT.....	47
FIGURE 30: GVR3550 LOCKED RECORDING MANAGEMENT PAGE.....	48
FIGURE 31: GVR3550 RECORDING SAVE PATH SETTING PAGE.....	48
FIGURE 32: GVR3550 MAIN MENU PAGE.....	49
FIGURE 33: GVR3550 CAMERA MANAGEMENT SETTING PAGE.....	50
FIGURE 34: GVR3550 MANUAL ADD CAMERA PAGE.....	51
FIGURE 35: GVR3550 RECORD MODE CONFIG PAGE.....	52
FIGURE 36: GVR3550 RECORD MODE SETTING PAGE.....	53
FIGURE 37: GVR3550 CAMERA EVENT SETTING PAGE.....	53
FIGURE 38: GVR3550 ENCODING CONFIG PAGE.....	55
FIGURE 39: GVR3550 ADD NEW SCHEDULE PAGE.....	57
FIGURE 40: GVR3550 SCHEDULE CONFIG - ADD NEW SCHEDULE - PAGE.....	58
FIGURE 41: GVR3550 SCHEDULE DETAILS PAGE.....	59
FIGURE 42: GVR3550 HOLIDAY CONFIG PAGE.....	60
FIGURE 43: GVR3550 ADD NEW HOLIDAY PAGE.....	61
FIGURE 44: GVR3550 ADD NEW HOLIDAY EDITING PAGE.....	61
FIGURE 45: GVR3550 HOLIDAY DETAILS PAGE.....	62
FIGURE 46: GVR3550 I/O ALARM CONFIG PAGE.....	63
FIGURE 47: GVR3550 I/O ALARM CONFIG – ADD NEW SCHEDULE - PAGE.....	64
FIGURE 48: GVR3550 ABNORMAL ALARM CONFIG PAGE.....	65
FIGURE 49: GVR3550 NETWORK SETTINGS – BASIC SETTING PAGE.....	66
FIGURE 50: GVR3550 NETWORK SETTINGS – ADVANCED SETTINGS PAGE.....	68
FIGURE 51: GVR3550 SPECIFY UPNP EXTERNAL PORT PAGE.....	69
FIGURE 52: GVR3550 SYSTEM SETTINGS PAGE – BASIC SETTINGS PAGE.....	70

FIGURE 53: GVR3550 SYSTEM SETTINGS PAGE – DATE & TIME .....	72
FIGURE 54: GVR3550 SYSTEM SETTINGS PAGE – DISPLAY SETTINGS .....	73
FIGURE 55: GVR3550 SYSTEM SETTINGS PAGE – EMAIL SETTINGS .....	74
FIGURE 56: GVR3550 SYSTEM SETTINGS PAGE – LOCAL VIEW CONTROL .....	75
FIGURE 57: GVR3550 LOCAL VIEW CONTROL – APPLY CAMERA .....	76
FIGURE 58: GVR3550 SYSTEM SETTINGS PAGE – HDD MANAGEMENT .....	76
FIGURE 59: GVR3550 HDD MANAGEMENT – ADD NEW VOLUME .....	77
FIGURE 60: GVR3550 HDD MANAGEMENT – EDIT VOLUME PROPERTY .....	77
FIGURE 61: GVR3550 SYSTEM SETTING PAGE – USER MANAGEMENT .....	79
FIGURE 62: GVR3550 USER MANAGEMENT – ADD USER .....	80
FIGURE 63: GVR3550 USER MANAGEMENT – EDIT USER .....	80
FIGURE 64: GVR3550 USER MANAGEMENT – EDIT NORMAL USER .....	81
FIGURE 65: GVR3550 USER MANAGEMENT – EDIT OPERATOR USER .....	81
FIGURE 66: GVR3550 SYSTEM SETTING PAGE – NTP SERVER .....	83
FIGURE 67: GVR3550 UPDATE – VIA HTTP .....	83
FIGURE 68: GVR3550 UPDATE – MANUAL UPDATE .....	84
FIGURE 69: GVR3550 BACKUP PAGE – RECORD BACKUP .....	85
FIGURE 70: GVR3550 BACKUP PAGE – QUICK BACKUP PAGE .....	86
FIGURE 71: GVR3550 BACKUP PAGE – QUICK BACKUP PROGRESS .....	86
FIGURE 72: GVR3550 BACKUP PAGE – SEARCH BACKUP .....	87
FIGURE 73: GVR3550 RESET & REBOOT PAGE .....	88
FIGURE 74: GVR3550 IMPORT & EXPORT PAGE .....	89
FIGURE 75: GVR3550 TROUBLESHOOTING PAGE .....	90
FIGURE 76: GVR3550 S.M.A.R.T. DETECTION PAGE .....	91
FIGURE 77: GVR3550 HDD BAD SECTOR DETECTION PAGE .....	92
FIGURE 78: GVR3550 SYSTEM LOG PAGE .....	93
FIGURE 79: GVR3550 RECORDING INFO PAGE .....	95
FIGURE 80: GVR3550 HDD SYSTEM INFO PAGE .....	96
FIGURE 81: GVR3550 HDD NETWORK INFO PAGE .....	97
FIGURE 82: GVR3550 HDD RESOURCE USAGE PAGE .....	98
FIGURE 83: GVR3550 ALARM INFO PAGE .....	99
FIGURE 84: GVR3550 HDD INFO PAGE .....	100
FIGURE 85: GVR3550 WEB PAGE – LOGIN .....	102
FIGURE 86: GVR3550 WEB PAGE – SYSTEM MENU .....	102
FIGURE 87: GVR3550 WEB REAL-TIME VIEW PAGE .....	103
FIGURE 88: GVR3550 WEB PLAYBACK PAGE .....	105
FIGURE 89: GVR3550 WEB PAGE – SYSTEM SETTINGS .....	106
FIGURE 90: GVR3550 WEB PAGE – MAINTENANCE MENU .....	107
FIGURE 91: GVR3550 WEB PAGE – DEBUG LOG .....	107
FIGURE 92: TFTP SERVER PAGE .....	110
FIGURE 93: TFTP DIALOG .....	110
FIGURE 94: TFTP SERVER DIRECTORY SETTINGS .....	111
FIGURE 95: CONFIRM MODIFICATION .....	111
FIGURE 96: GVR3550 WEB PAGE – MANUAL UPDATE .....	113
FIGURE 97: GVR3550 FACTORY RESET POP-UP PAGE .....	114
FIGURE 98: GVR3550 FACTORY RESET ON LOCAL WEB PAGE .....	115

## TABLE OF TABLES

TABLE 1: GXV3550 PACKAGE LIST:.....	12
TABLE 2: GXV3550 OPTIONAL EQUIPMENT LIST: .....	12
TABLE 3: GXV3550 SOFT KEYBOARD EXPLANATION: .....	19
TABLE 4: GXV3550 SOFTWARE SPECIFICATIONS: .....	22
TABLE 5: GXV3550 HARDWARE SPECIFICATIONS:.....	23
TABLE 6: GXV3550 FRONT PANEL EXPLANATION: .....	24
TABLE 7: GXV3550 BACK PANEL EXPLANATION:.....	26
TABLE 8: GXV3550 REMOTE CONTROL KEY EXPLANATION:.....	28
TABLE 9: GVR3550 PREVIEW STATUS EXPLANATION: .....	33
TABLE 10: GVR3550 SYSTEM ABNORMAL ALARM SCREEN EXPLANATION: .....	34
TABLE 11: GVR3550 BASIC VIEW OPERATION EXPLANATION: .....	34
TABLE 12: GVR3550 PTZ CONTROL PARAMETER EXPLANATION: .....	37
TABLE 13: GVR3550 RIGHT CLICK MOUSE MENU PARAMETER EXPLANATION:.....	41
TABLE 14: GVR3550 RECORDING STATUS PARAMETER EXPLANATION: .....	44
TABLE 15: GXV3550 RECORD PLAYBACK TOOLBAR EXPLANATION: .....	46
TABLE 16: GVR3550 CAMERA PARAMETER SETTING EXPLANATION:.....	51
TABLE 17: GVR3550 CAMERA EVENTS SETTOMGS EXPLANATION .....	54
TABLE 18: GVR3550 CAMERA ALARM PARAMETER EXPLANATION: .....	54
TABLE 19: GVR3550 ENCODING CONFIG PARAMETER EXPLANATION: .....	55
TABLE 20: GVR3550 IO ALARM CONFIG PARAMETER EXPLANATION: .....	63
TABLE 21: GVR3550 ABNORMAL ALARM PARAMETER EXPLANATION:.....	65
TABLE 22: GVR3550 BASIC NETWORK PARAMETER EXPLANATION: .....	67
TABLE 23: GVR3550 BASIC SYSTEM SETTING PARAMETER EXPLANATION: .....	71
TABLE 24: GVR3550 BASIC SYSTEM SETTING – DATE & TIME PARAMETER EXPLANATION:.....	72
TABLE 25: GVR3550 BASIC SYSTEM SETTING – DISPLAY PARAMETER EXPLANATION:.....	73
TABLE 26: GVR3550 EMAIL TEMPLATE PARAMETER EXPLANATION:.....	75
TABLE 27: GVR3550 EDIT VOLUME PROPERTY PARAMETER EXPLANATION: .....	78
TABLE 28: GVR3550 HDD RAID PARAMETER EXPLANATION: .....	78
TABLE 29: GVR3550 HDD MANAGEMENT PARAMETER EXPLANATION: .....	78
TABLE 30: GVR3550 UPGRADE PARAMETER EXPLANATION:.....	84
TABLE 31: GVR3550 CONFIG FILE IMPORT & EXPORTPARAMETER EXPLANATION: .....	90
TABLE 32: GVR3550 NETWORK DIAGNOSE PARAMETER EXPLANATION: .....	91
TABLE 33: GVR3550 HDD S.M.A.R.T DETECTION PARAMETER EXPLANATION: .....	92
TABLE 34: GVR3550 HDD BAD SECTOR DETECTION PARAMETER EXPLANATION: .....	93
TABLE 35: GVR3550 SYS LOG PARAMETER EXPLANATION: .....	94
TABLE 36: GVR3550 DEVICE STATUS PARAMETER EXPLANATION:.....	98
TABLE 37: GVR3550 REMOTE PREVIEW OPERATION EXPLANATION:.....	104
TABLE 38: GVR3550 REMOTE PREVIEW CAMERA INFORMATION EXPLANATION:.....	105
TABLE 39: GVR3550 DEBUG LOG PARAMETER EXPLANATION: .....	108

## WELCOME

Thank you for purchasing Grandstream GVR3550 NVR (Network Video Recorder).

The GVR3550 is a NVR product integrating multi-camera preview, playback and intelligent alarm monitoring with epoch-making innovation. It is equipped with great hardware and vigorous supporting system, providing the most advanced network video monitoring technology to meet the requirement for the live view, instant playback and data locking, file security, etc. SMB throughout the world can now use the GVR3550 to meet the productivity needs.



Integrating the leading performance and function in the NVR field, the GVR3550 also features express installation, easy deployment and incomparable reliability.

This user manual is designed to help customers to understand how to configure and manage the GVR3550 with detailed instruction including advanced settings and operating, such as alarm settings and record settings.



## SAFETY COMPLIANCES

These instructions are intended to assist users to safely operate the GVR3550, avoid dangerous situations or damage the device.

	
<p><b>Warning :</b> May cause serious injury or death if any of the warnings below are neglected.</p>	<p><b>Caution:</b> Equipment may be damaged if any of the following caution messages are neglected.</p>



### Warning:

Input voltage should meet both the SELV (Safety Extra Low Voltage) and the Limited Power Source with DC 12V according to the IEC60950-1 standard. Please refer to the technical specifications for more details. Do not use a third-party power adapter or power cord. When the device installed on the wall or ceiling, make sure that it is firmly attached.



### Caution:

- Make sure that the power supply voltage is correct before using the camera.
- Do not drop the device or expose it to physical shock.
- Do not expose the device to temperatures outside the range of 0 °C to +50°C when the device is in operation.
- Do not expose the device to damp/wet conditions or high electromagnetism radiation.
- To avoid heat accumulation, make sure that your operating environment has proper ventilation.
- Do not damage the warranty sticker.

A few parts (e.g. electrolytic capacitor) of the equipment shall be replaced regularly according to their average lifetime. The average lifetime varies from the differences between operating environments and usage history. Regular maintenance checks are recommended for all users. Please contact your dealer for more details.

## **FCC CAUTION**

Any Changes or modifications not expressly approved by the party responsible for compliance could void the user's authority to operate the equipment. This device complies with part 15 of the FCC Rules. Operation is subject to the following two conditions:

- 1) This device may not cause harmful interference.
- 2) This device must accept any interference received, including interference that may cause undesired operation.

Note: This equipment has been tested and found to comply with the limits for a Class B digital device, pursuant to part 15 of the FCC Rules.

These limits are designed to provide reasonable protection against harmful interference in a residential installation. This equipment generates uses and can radiate radio frequency energy and, if not installed and used in accordance with the instructions, may cause harmful interference to radio communications. However, there is no guarantee that interference will not occur in a particular installation. If this equipment does cause harmful interference to radio or television reception, which can be determined by turning the equipment off and on, the user is encouraged to try to correct the interference by one or more of the following measures:

- Reorient or relocate the receiving antenna.
- Increase the separation between the equipment and receiver.
- Connect the equipment into an outlet on a circuit different from that to which the receiver is connected.
- Consult the dealer or an experienced radio/TV technician for help.

## **RF EXPOSURE INFORMATION (SAR)**

This device is designed and manufactured not to be exceeded the emission limits for exposure to radio frequency RF energy set by the Federal Communications Commission of the United States. The exposure standard for wireless devices employing a unit of measurement is known as the Specific Absorption Rate (SAR), and the SAR limit set by FCC is 1.6 W/kg.

This device is complied with SAR for general population/uncontrolled exposure limits in ANSI/IEEE C95.1-1992, and has been tested in accordance with the measurement methods and procedures specified in OET Bulletin 65 Supplement C. This device has been tested, and meets the FCC RF exposure guidelines when tested with the device directly contacted to the body. RF exposure compliance with anybody-worn accessory, which contains metal, was not tested and certified, and uses such body-worn accessory, should be avoided.

Changes or modifications not expressly approved by the party responsible for compliance could void the user's authority to operate the equipment.

Hereby, Grandstream declares that this device is in compliance with the essential requirements and other relevant provisions of Directive 1999/5/EC.

## WARRANTY

If the GVR3550 was purchased from a reseller, please contact the company where the device was purchased for replacement, repair or refund.

If the device was purchased directly from Grandstream, please contact our technical support team for a RMA (Return Materials Authorization) number before the product is returned.

Grandstream reserves the right to remedy warranty policy without prior notification.



### Caution:

Changes or modifications to this product not expressly approved by Grandstream, or operation of this product in any way other than as detailed by this User Manual, could void your manufacturer warranty.



### Warning:

Please do not use a different power adaptor with the GVR3550 as it may cause damage to the products and void the manufacturer warranty.

---

- This document is subject to change without notice. The latest electronic version of this user manual is available for download at:
- [http://www.grandstream.com/products/surveillance/GVR3550/documents/GVR3550\\_UM\\_EN.pdf](http://www.grandstream.com/products/surveillance/GVR3550/documents/GVR3550_UM_EN.pdf)

*Reproduction or transmittal of the entire or any part, in any form or by any means, electronic or print, for any purpose is not permitted without the express written permission of Grandstream Networks, Inc.*

# INSTALL GVR3550

## EQUIPMENT PACKAGE CONTENTS

The GVR3550 package contains:

**Table 1: GXV3550 Package List:**

Number	Name	Number
1	Main Case	1
2	12V Power Adapter and Power Cord	1
3	Ethernet Cable	1
4	Remote Control (No Battery)	1
5	SATA HDD Power Cable	2
6	SATA HDD Signal Cable	4
7	Mount Brackets	4
8	Screws	12
9	HDD Installation Screws	18
10	Quick Installation Guide	1

To establish a working surveillance system, users have to get following equipment based on own requirement. The following table is for reference only.

**Table 2: GXV3550 Optional Equipment List:**

#	Device Name	Number	Explanation
1	Video Display Device	1	Mornitor, TV (either OK but at least one required)
2	IP Cameras	1 (Minimum)	IP Network Cameras
3	Keyboard	Optional	USB Keyboard
4	Mouse	Optional	USB Mouse
5	Hard Disk Driver	1 (Minimum)	Compatible SATA HDD, Max. capacity 4TB.
6	Audio Device	Optional	Audio In/Out Device: Microphone, Speaker.

7	Alarm Device	Optional	Alarm In/Out Device: Smoke Sensor, IR Sensor, Magnetic Sensor, Siren, etc.
---	--------------	----------	--

## CONNECTING THE GVR3550

To set up a complete set of monitoring system, user needs to provide your own equipment listed below:

- One (1) Display device (could LED monitor or TV)
- At least one (1) Video Acquisition Processing Equipment (e.g.: IP Cameras)
- Optional USB mouse
- Optional USB keyboard
- At least one (1) HDD (Compatible SATA is required. The maximum capacity is no more than 4T.)
- Optional Audio Device (Audio input/output device: mono, microphone or pickups, etc.)
- Optional Alarm Device (Alarm input/output device: smoke detector, infrared detector, siren, etc.)

The GVR3550 contains no HDD with packaging, users need to check the device and install HDD the first time using it.

## INSTALLING HDD

We suggest to use the recommended HDD by Grandstream (7200 RPM HDD and higher), the dedicated PC HDD is not recommended.

Please install the GVR3550 HDD according to the following procedures:

1. Twist four screws gently on the bottom of HDD, do not twist too tight.
2. Remove the fixed screws on the back and side panel of the main case, open the cover plate to find the HDD installing position.
3. Side put the main case, aims the HDD with four screws at the corresponding round holes on the baseplate, push the screws to the screw holes to stick them.
4. Twist the screws.
5. Repeat the previous steps to install other HDDs.
6. Connect HDD cables and power cables to the interfaces of the mainboard.
7. Put the cover plate back to GVR and twist the screws.



**NOTE:**

- *Recommended using at least 7200rpm HDD.*
- *GVR3550 does NOT support HDD hot swap. When GVR3550 is running, plug the HDD may cause fail to read /write HDD data or unable to identify or access HDD. Grandstream will take no responsibility for the damage caused by wrong operation.*

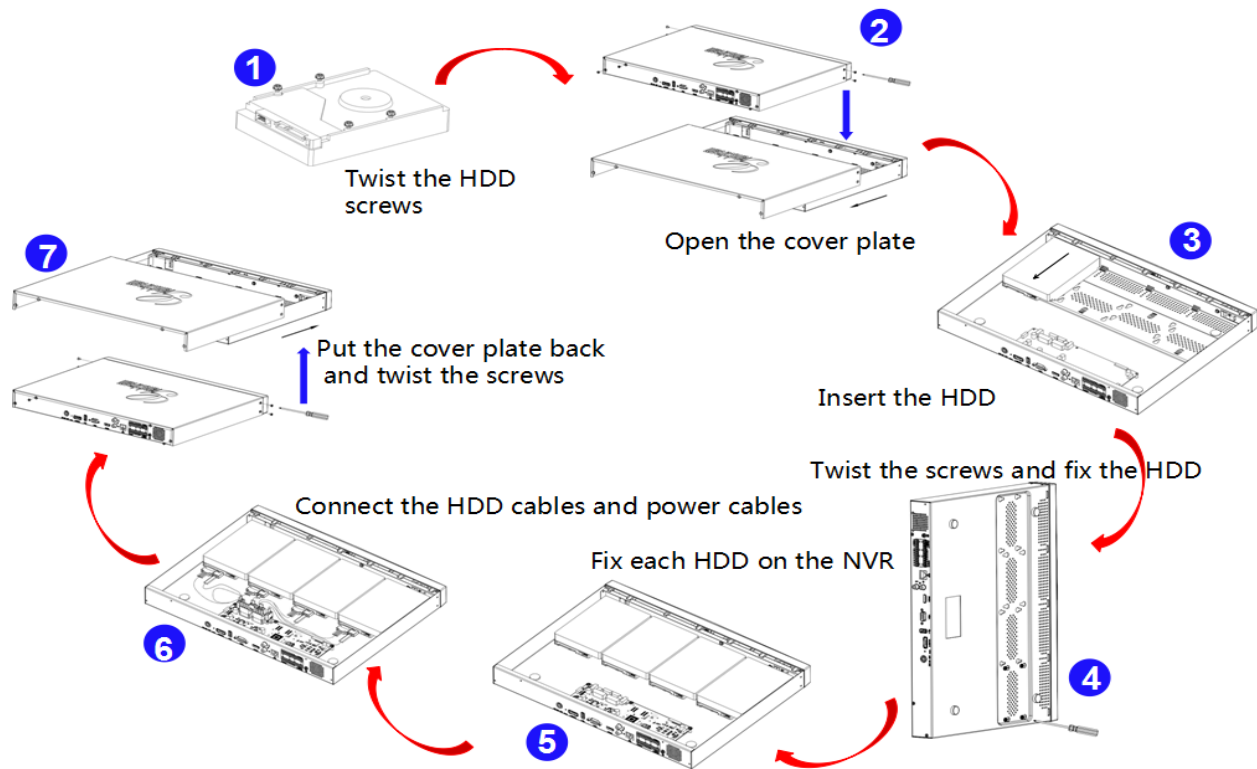

**Figure 1: GVR3550 HDD Installation**

## SYSTEM CONNECTION

Please connect the GVR3550 according to the following procedures:

1. Install the GVR3550 HDD by following the steps in chapter *Installing HDD*.
2. Plug in the cables and connect it to the display device interface.
3. Connect the mouse, keyboard, alarm input and output devices (optional).
4. Power up those optional devices before connecting power cable and power up the GVR3550.
5. Power up GVR3550, the power indicator will solid green; The HDD indicator will blink when it works; The fn indicator will solid green if user presses function button.

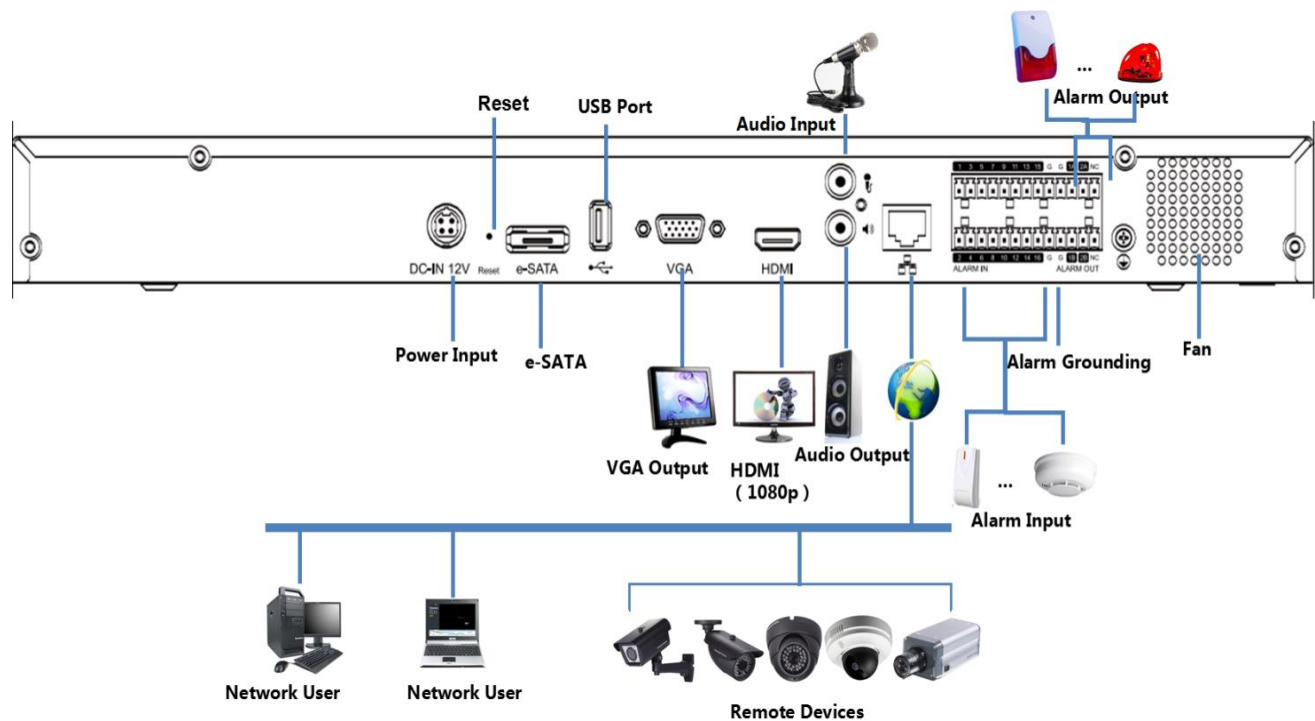

Figure 2: GVR3550 System Connection Diagram

## NETWOKR CONNECTION

Users could login the Web page with the administrator account after plugging in the network cable to the GVR3550, go to Main Menu ->Status-> Network Status to check the network status including IP address and network send/receive rate as shown in Figure 3. For details, please refer to the chapter *Network Info*.

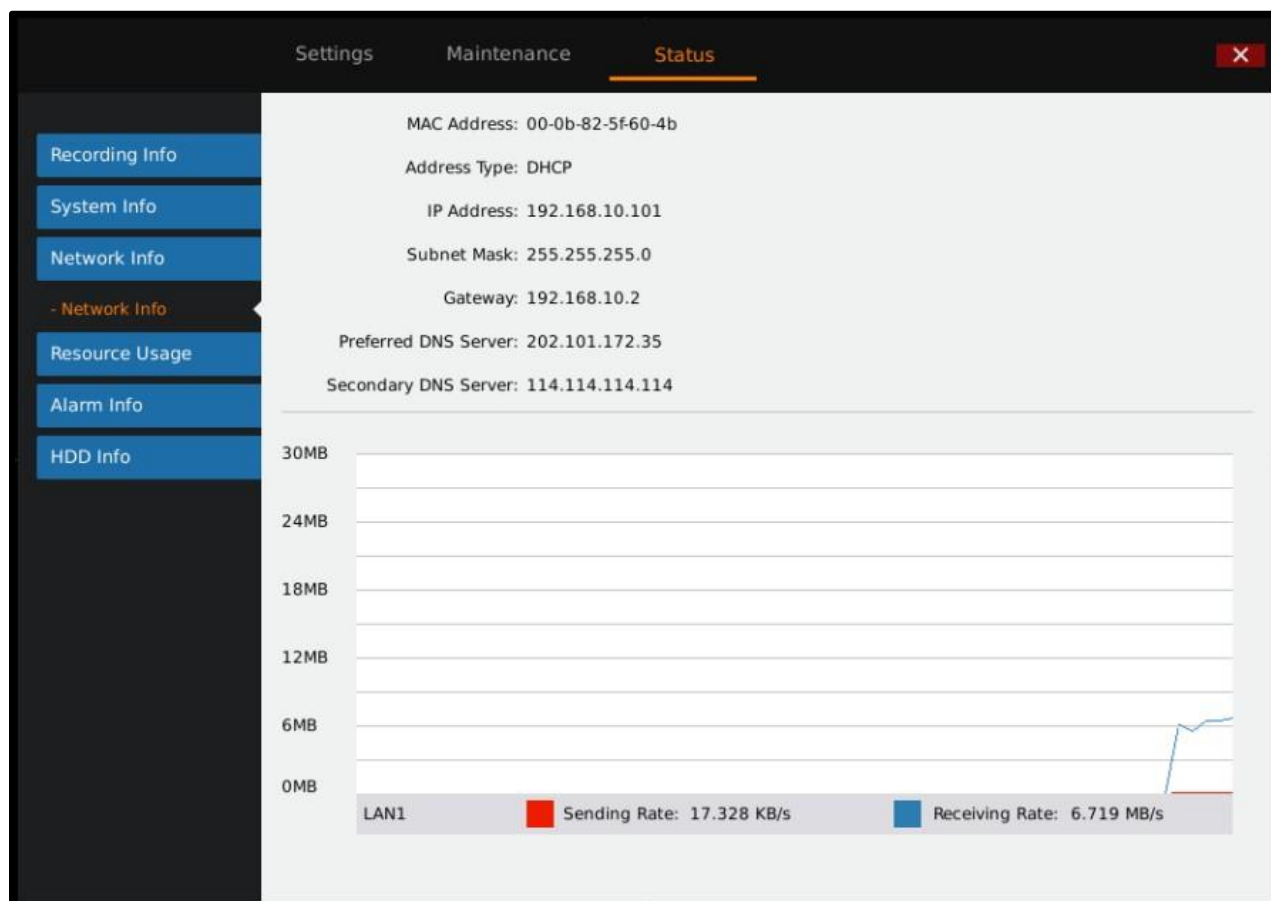

Figure 3: GVR3550 “Status” → “Network Info” Page

## EXTERNAL USB DEVICE

GVR3550 USB interface could be connected to mouse and keyboard, or a USB storage device.



**NOTE:**

*The USB interface voltage on the front panel of the GVR3550 is a little higher than the one on the rear panel, it is suggested that the USB interface on the rear panel connect to mouse and keyboard while the one on the front panel connect to USB storage devices.*



## PLUG IN USB MOUSE/KEYBOARD

Users could check whether the mouse and keyboard installation is successful after plugging in them. The mouse or keyboard might be not compatible with the GVR3550 if cannot be detected, please replace the mouse or keyboard and try again.

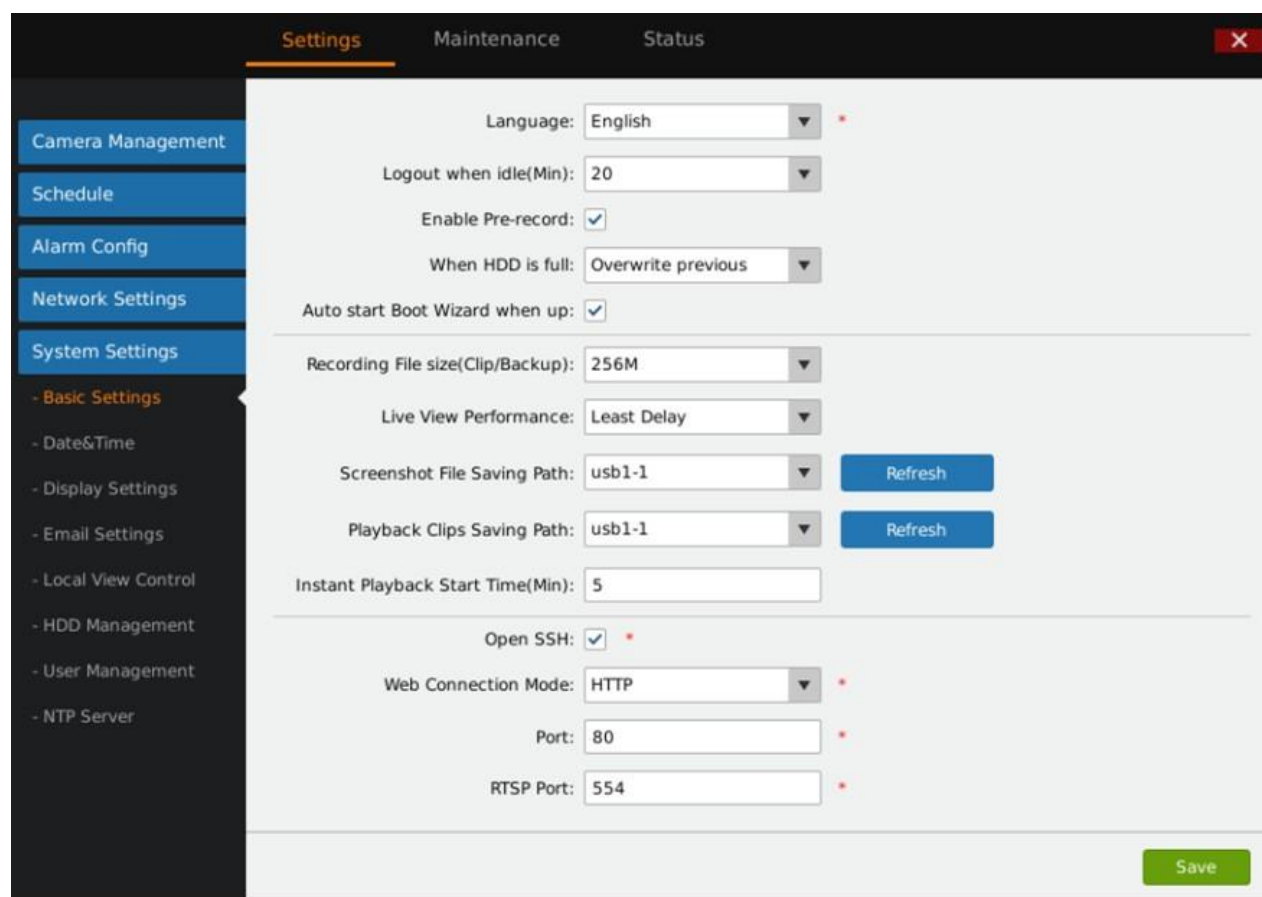

**Figure 4: GVR3550 System Setting Page**

When the USB mouse is plugged into the GVR3550, users could make the following operations with the mouse.

Single click the left mouse:

- Enter a functional menu.
- Change the dialog box or dynamic status.
- Bring up the drop-down list when clicking the combo box.
- Switch input methods in the input box, tap on the corresponding buttons on the soft keyboard to input numbers.

Double click the left mouse:

Double click on one screen to switch to full screen in multi-screen view mode. Double click again to exit and go back to the previous multi-screen status.

Single click the right mouse:

- Bring up the shortcut menu in real-time monitoring mode.
- Do not save the menu options and exit the current menu, go back to the preview screen.

Scroll wheel:

- Scroll up and down the list box.
- Mouse Move.
- Select one control or one entry below it with cursor.



**NOTE:** *If in a rare case that the mouse is not detected, the mouse might not compatible with the GVR3550, please replace the mouse.*

---

## **INPUT METHOD**

The GVR3550 supports English and Chinese input methods; the input interface is as shown below.



**Figure 5: GVR3550 Soft Keyboard – English Input Method**



**Figure 6: GVR3550 Soft Keyboard – Chinese Input Method**



Figure 7: GVR3550 Soft Keyboard – Symbol and Number

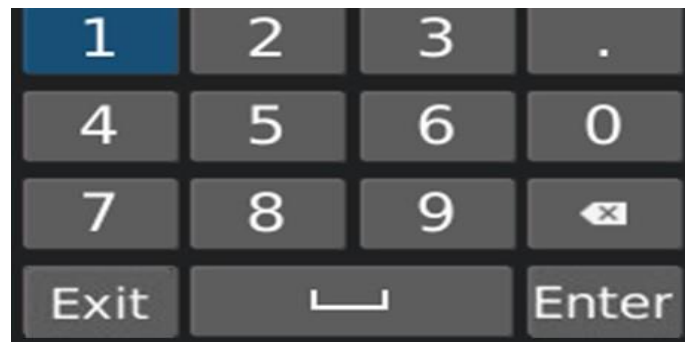

Figure 8: GVR3550 Soft Keyboard – Numeric Keyboard

Table 3: GXV3550 Soft Keyboard Explanation:

abc	Input lowercase
⇧	Switch Caps Lock
Exit	Sequin
?123	Switch to Numbers & Symbols
EN	Switch to alphabet
␣	Space
CH	Switch to Chinese input method
Enter	Enter
⌫	Backspace

### PLUG IN USB STORAGE DEVICE

Users could click right mouse to check if there is "Uninstall" option in the menu after plugging in the USB device correctly. The option means the USB device is normal for use. Users could also go to Settings->System Settings->Basic System Settings, click "Refresh" as shown in figure below to check the USB device status.

## INSTALLING eSATA

Plug in the eSATA cable to the corresponding interface on the rear panel of the GVR3550, power up eSATA or electrify it with USB cable (according to eSATA specific situation). Users could go to Settings->System Settings->HDD Management to view details like HDD Space, Free Space, HDD Status, HDD Type after installing eSATA. For details, please refer to the chapter **HDD Management**.

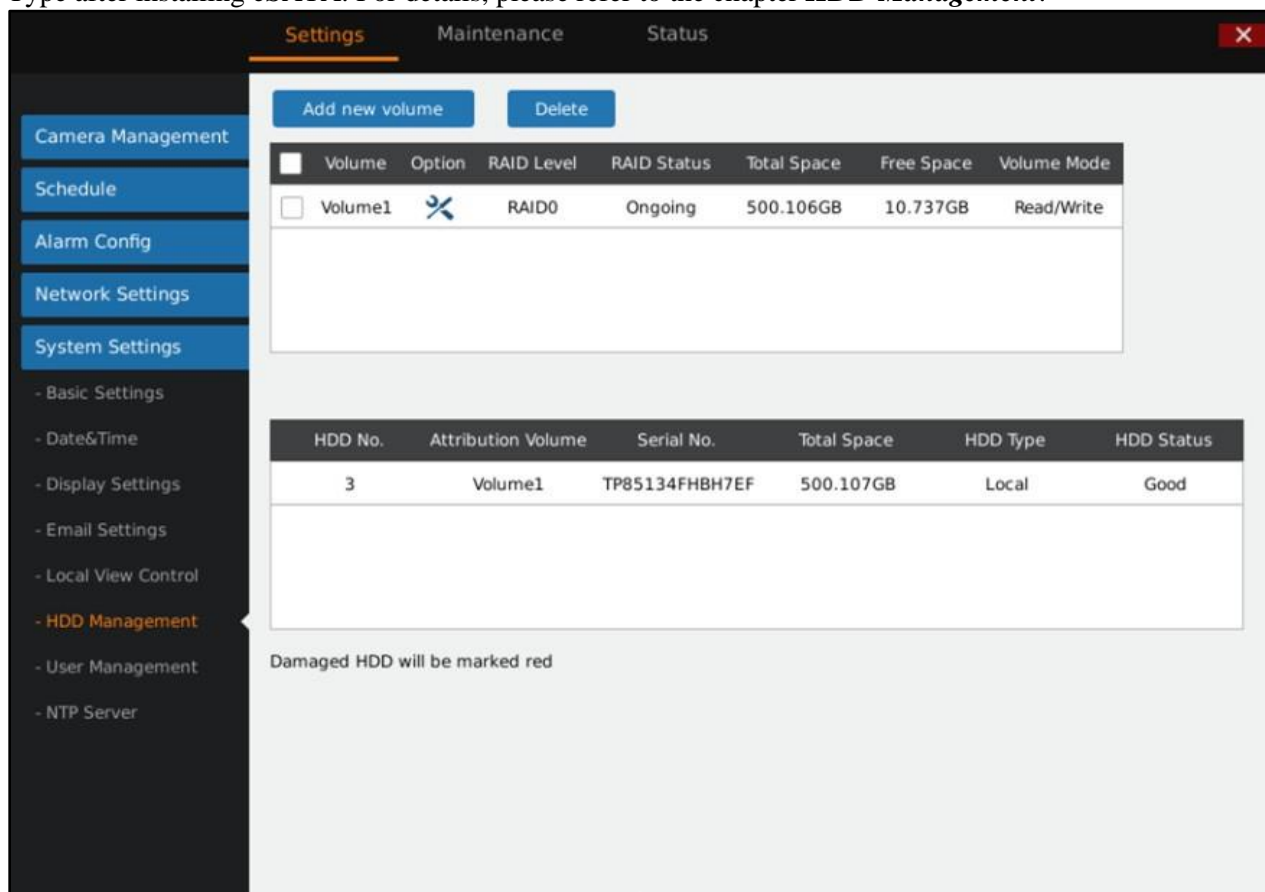

Volume	Option	RAID Level	RAID Status	Total Space	Free Space	Volume Mode
<input type="checkbox"/> Volume1		RAID0	Ongoing	500.106GB	10.737GB	Read/Write

HDD No.	Attribution Volume	Serial No.	Total Space	HDD Type	HDD Status
3	Volume1	TP85134FHBH7EF	500.107GB	Local	Good

Damaged HDD will be marked red

**Figure 9: GVR3550 HDD Management Page**

## CONNECT HDMI MONITOR

Connect one end of the HDMI cable to the port on the rear panel of the GVR3550, and the other end to the corresponding port of the HDMI monitor. Once powered up, one preview screen of the GVR3550 appears on the HDMI monitor. GVR3550 can automatically adapt to HDMI monitor with 1080p and 720p resolution.

## CONNECT VGA MONITOR

Connect one end of the VGA cable to the port on the rear panel of the GVR3550, and the other end to the corresponding port of the VGA monitor. Once powered up, the boot screen of the GVR3550 appears on the VGA monitor.



**NOTE:**

- *VGA does not support automatic resolution matching.*
- *There is only one valid output when connect to VGA and HDMI monitor the same time. HDMI is valid while VGA is not by default. Users can also go to System Settings->Display to set parameters like Screen resolution, brightness, contrast, saturation and hue.*

## **CONNECT ALARM DEVICE**

Alarm input/output connection procedures are as follows:

1. Connect the alarm input device to the alarm input port.
2. Connect the alarm output device to the alarm output port.
3. Enter the GVR3550 main menu, set corresponding settings to alarm input/output on the Alarm Settings page. Alarm serial number 1 corresponds to the first alarm input on the GVR3550 I / O port, the following numbers keep to the same matching sequence. Set normally-opened alarm and normally-closed alarm according to the corresponding high /low electrical when alarm.
4. Set alarm output on the Alarm Settings page. Alarm output 1 corresponds to the first alarm output; the following numbers keep to the same matching sequence.

## **EXTERNAL INTERCOM DEVICE**

GVR3550 support web paging and local paging:

1. Connect the audio-input device like microphone or pickups with RCA port to the audio input port on the rear panel.
  2. Connect the audio-output device like speaker or stereo with RCA port to the audio output port on the rear panel. (The steps above ensure the GVR3550 could input or output audio)
  3. Connect the microphone to the audio input of PC, the earphone or stereo to the audio output of PC.
- Connect the audio input/output device to the compatible cameras.

# PRODUCT OVERVIEW

## GVR3550 SPECIFICATIONS

**Table 4: GXV3550 Software Specifications:**

Specification	Description
<b>Video Recording</b>	Supports synchronous 24 channels 720p (with 1280x720 resolution) record or 12 channels 1080p (with 1920x1080 resolution) record
<b>Recording Rate</b>	Supports up to 48 Mbps recording rate
<b>Recording Mode</b>	Supports continuous record, schedule record ,alarm record and manual record
<b>Video Encoding</b>	H.264 baseline, main or higher
<b>Audio Encoding</b>	G.711 a/u law
<b>Live View</b>	Up to 16 channels of VGA, 4 channels of 720p, or 2 channels of 1080p via HDMI or VGA output
<b>Playback</b>	Supports synchronous local or remote 4 channels playback.
<b>Trigger Event Alarm</b>	Trigger modes: manual alarm, schedule alarm, IPC alarm, I/O alarm, event alarm and abnormal alarm
<b>Intelligent Retrieval</b>	Intelligent retrieval modes: retrieval by Date & Time, motion detection
<b>Total Storage</b>	Up to 16TB internally with encryption; additional storage available via external eSATA
<b>RAID</b>	Supports RAID 0 and RAID 1
<b>Redundancy</b>	Supports records backup to USB
<b>QoS</b>	Layer 2 QoS (802.1Q, 802.1p) and Layer 3 QoS (ToS, DiffServ, MPLS) (Layer 3 QoS coming soon)
<b>Protocol</b>	Supports HTTP, HTTPS, ONVIF protocol
<b>Network Protocol</b>	TCP/UDP, RTP/RTCP/RTSP, HTTP/HTTPS, ARP, ICMP, DNS, DDNS, DHCP (client and server), NTP (client and server), SSH, PPPoE, LLDP (pending), 802.1X, ONVIF 2.2
<b>IP Camera</b>	Supports all Grandstream GXV36xx series IPC or some ONVIF compatible IPCsI
<b>Security Protocol</b>	Supports HTTPS, 802.1x, SSH

**Table 5: GXV3550 Hardware Specifications:**

Name	Description
<b>Interface</b>	1 HDMI interface; 1 VGA interface; 1 x 10/100/1000Mbps auto-sensing RJ45 port; 1 RCA Audio Input & Output interface
<b>Alarm In</b>	Terminal 16 inputs (NO/NC), Vin 2.5V~12V, Iin 2.5mA~30mA
<b>Alarm Out</b>	Terminal 2 outputs (Relay), 0.5A at 125 VAC; 2A at 30 VDC
<b>UPS</b>	UPS Management (pending)
<b>USB Interface</b>	Two 2.0 USB interfaces
<b>eSATA</b>	1 eSATA interface
<b>LED Indicator</b>	Power, LAN Link/Activity, Hard Drive Activity, fn
<b>Remote Control</b>	Supports IR remote control
<b>RTC</b>	Supports RTC
<b>Internal HDD</b>	Up to 4 3.5" SATA hard drives with maximum 16TB storage (HDD not included)
<b>Universal Power Supply</b>	Input: 100~240V 50/60Hz; Output: 12V/5A 60W
<b>Environmental</b>	Operation: 0°C to 50°C Storage: -20°C to 60°C (HDDs not included) Humidity: 10% to 90% non-condensing
<b>Installations</b>	1U rack mount with front brackets
<b>Compliance</b>	FCC: Part 15 (CFR 47) Class B FCC: Part 15, (CFR 47) Class B CE: EN 55022, EN 55024, EN 61000-3-2, EN 61000-3-3, EN 60950 RCM: AS/NZS CISPR22, AS/NZS CISPR24, AS/NZS 60950 Comply with R & TTE, RoHS & WEEE

## GVR3550 FRONT PANEL

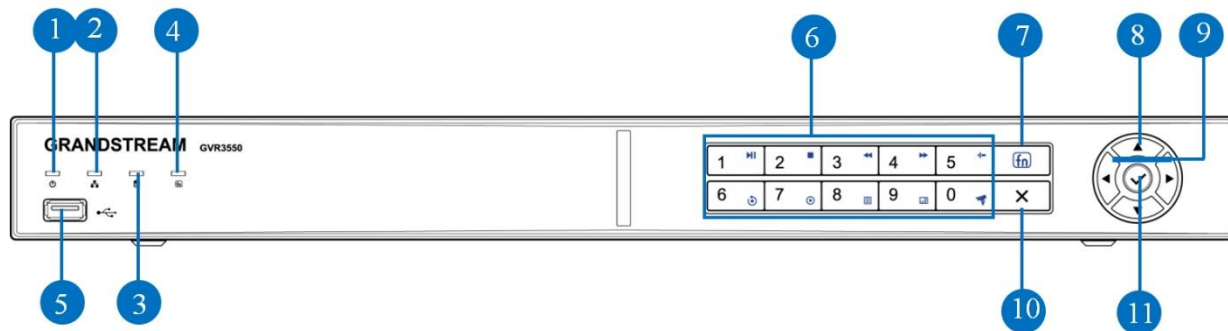





















Figure 10: GVR3550 Front Panel

Table 6: GXV3550 Front Panel Explanation:

#	Icon	Name	Explanation
1.		<b>Power indicator</b>	Power indicator will solid Green when GVR powers up.
2.		<b>Network Indicator</b>	When the network is abnormal or the GVR has no access to the network, the indicator does not flicker when alarm; When the network connection is normal the green indicator is normally on; When transmitting data, the indicator flickers green.
3.		<b>HDD Indicator</b>	The indicator will flicker Green if the HDD runs normally. If the HDD capacity is full, GVR will display a warning prompt on screen.
4.		<b>Status Indicator</b>	To indicate whether the numeric buttons features other functions. When press the function button, the numeric buttons would feature as function buttons. The indicator turns green when the numeric buttons are in functional mode while in numeric mode the indicator is dark.
5.		<b>USB Interface</b>	To connect to USB device like mouse, keyboard and USB flash drive.
6.		<b>Numeric / Function Buttons</b>	To input numbers and switch preview. When press the function button, the numeric buttons will be used as function buttons. Number 0-9 are corresponding to the following functions: Enable PTZ  , Start/Pause  , Stop  , Fast Backward  , Fast Forward  , Playback  , Record  , Single Frame  , Menu  , Multiscreen  .
7.		<b>Function Button</b>	To switch between numeric mode and function mode. The function status indicator indicates the status of the function button.



8.		<b>Up and Down Direction Buttons</b>	<ul style="list-style-type: none"> <li>• To switch among the activated controls or move up or down.</li> <li>• Revise settings, add or subtract numbers.</li> <li>• Auxiliary Function: Navigate the PTZ menu up or down.</li> </ul>
9.		<b>Left and Right Direction Buttons</b>	<ul style="list-style-type: none"> <li>• To switch among the activated controls or move left or right.</li> <li>• Controls the progress bar when playback.</li> <li>• Auxiliary Function: Navigate the PTZ menu left or right.</li> </ul>
10.		<b>Cancel Button</b>	<ul style="list-style-type: none"> <li>• Back to the previous menu or cancel operation.</li> <li>• Back to real-time monitoring state when playback.</li> </ul>
11.		<b>Confirm Button</b>	<ul style="list-style-type: none"> <li>• Confirm.</li> <li>• Switch to the default button.</li> <li>• Enter menu.</li> <li>• Switch between check box and ON/OFF button.</li> <li>• Pause/Resume auto patrol in the auto patrol preview mode.</li> </ul>

## GVR3550 BACK PANEL

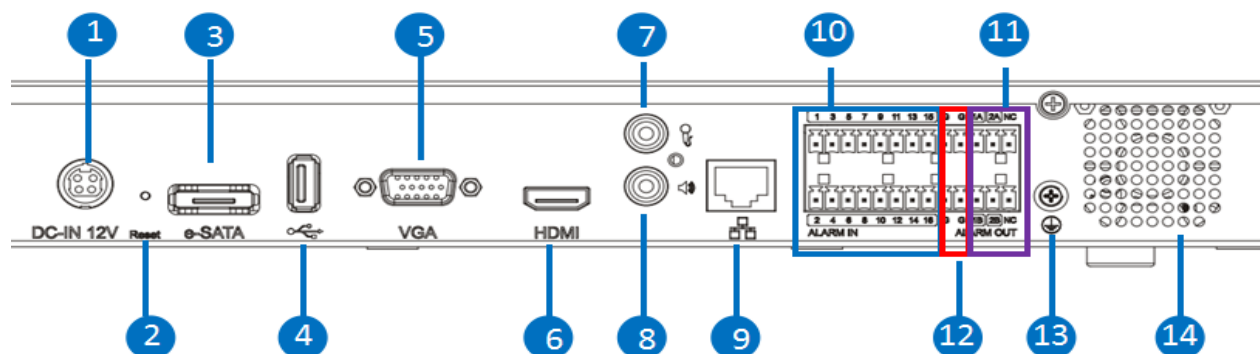







Figure 11: GVR3550 Back Panel

Table 7: GXV3550 Back Panel Explanation:

#	Icon	Name	Explanation
1	DC-IN 12V	<b>Power Input</b>	Power interface, input 12V DC.
2	Reset	<b>Reset Button</b>	To reboot device or reset factory. <ul style="list-style-type: none"> <li>• Long press for more than 10 seconds: factory reset.</li> <li>• Press when power on, reset when the GVR is abnormal.</li> </ul>
3	e-SATA	<b>eSATA Interface</b>	To connect eSATA device
4		<b>USB Interface</b>	To connect to USB devices, like mouse, keyboard and USB flash drive.
5	VGA	<b>VGA Output</b>	Output analog video signal, connecting to a monitor to view the video.
6	HDMI	<b>HDMI Output</b>	HD audio/video output interface, transmit uncompressed HD video and multi-camera audio data to the display device with HDMI interface.
7		<b>Audio Input</b>	Audio input interface, receiving analog audio signal from microphone and other devices.
8		<b>Audio Output</b>	Output analog audio signal to device like Speaker
9		<b>Network Port</b>	10M/100M/1000M adaptive Ethernet interface.
10	ALARM IN	<b>Alarm Input 1~16</b>	16 alarm input interface, receiving binary signals of external alarm like normally-closed alarm and normally-open alarm.  When electrify the alarm input device with external power, the device should be common-grounded with the GVR.

11	ALARM OUT	<b>Alarm output</b> 1~2:	2 sets alarm output interface, output alarm signal to the external alarm device, power supply is required for external alarm device.
12	--	<b>Alarm Grounding</b>	Public alarm input grounding interface
13		<b>Grounding</b>	Grounding
14	--	<b>FAN</b>	For heat dissipation

## IR REMOTE CONTROL

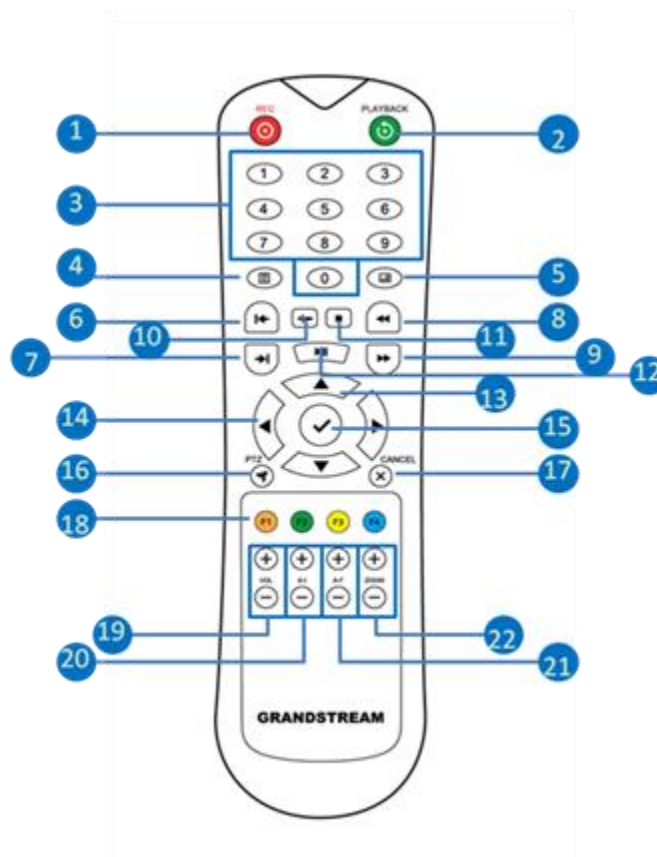













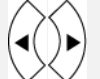





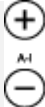



Figure 12: IR Remote Control

**Table 8: GXV3550 Remote Control Key Explanation:**

#	Icon	Name	Explanation
1		<b>REC Button</b>	Manual start/stop recording. Use REC button and the direction buttons to select the camera to record in the record control menu.
2		<b>Playback Button</b>	Enter playback screen
3		<b>Numeric Buttons</b>	Features the same function as the numeric buttons on the front panel (Only numeric function) and switch review screen.
4		<b>MENU Button</b>	Enter menu
5		<b>Multiscreen Button</b>	Switch the display to a single screen or multiscreen
6		<b>Single-frame back Button</b>	Single frame playback of the record
7		<b>Single-frame Step Button</b>	Single frame forward of the record
8		<b>Fast Backward Button</b>	Various fast backward and normal playback modes, the speed would be displayed on the playback screen
9		<b>Fast Forward Button</b>	Various fast forward and normal playback modes, the speed would be displayed on the playback screen
10		<b>Skip Button</b>	Switch to skip mode. User SKIP button with the UP&DOWN buttons to decide when to play records.
11		<b>STOP Button</b>	Stop playing recorded video.
12		<b>PLAY/PAUSE Button</b>	<ul style="list-style-type: none"> <li>Press the button to playback when playback pauses.</li> <li>Press the button to pause playback when playback.</li> </ul>
13		<b>UP &amp; DOWN Direction Buttons</b>	<ul style="list-style-type: none"> <li>Switch the activated controls to up or down.</li> <li>Switch cameras to up or down when preview</li> <li>Auxiliary function (e.g.: Control and operate the PTZ menu).</li> </ul>
14		<b>LEFT &amp; RIGHT Direction Buttons</b>	<ul style="list-style-type: none"> <li>Switch the activated controls to left or right.</li> <li>Switch cameras to left or right when preview.</li> <li>Control the progress bar when playback record.</li> <li>Auxiliary function (e.g.: Control and operate the PTZ menu).</li> </ul>
15		<b>ENTER Button</b>	<ul style="list-style-type: none"> <li>Confirm operations.</li> <li>Switch to the default button</li> </ul>
16		<b>PTZ Control Button</b>	Enable/Disable PTZ Control
17		<b>Cancel Button</b>	Back to the upper level, menu or cancel operations when pressing the function menu button (Close the top-level page or controls).
18		<b>Function Buttons 1-4</b>	F1, F2, F3 and F4 Function buttons.

19		<b>Vol Button +/-</b>	Adjust the volume of the cameras when preview or its volume when play back record.
20		<b>A-I Button +/-</b>	Adjust aperture at PTZ control
21		<b>A-F Button +/-</b>	Adjust focus at PTZ control
22		<b>Zoom Button +/-</b>	<ul style="list-style-type: none"> <li>• Electronic zoom adjustment at PTZ control.</li> <li>• Electronic zoom adjustment when one camera. Playback record at full screen.</li> </ul>

The correct way to use IR remote control: Batteries must be installed before use. Please aim the remote control at the IR receiver on the GVR3550 then make operations. If the GVR3550 receives the control's command, you can use the control to manipulate the GVR3550. If failed, please check whether the following reasons are the causes:

- Check the battery polarities
- Check whether the battery power
- Check whether the remote sensor is obscured.
- Check whether a fluorescent lamp is being used nearby.
- If the remote still cannot function normally beyond the above situations, please change a remote and try again, or contact the device provider.

## LOCAL OPERATIONS

In this chapter, we take using the mouse as an example.

### USING THE WIZARD

Users could use the wizard for basic configuration once started the GVR3550 to make it work properly.

1. Enter administrator password (The default is "Admin") to log in the GVR. Check to confirm whether to enable the wizard next time boot up the unit.
2. Click on "Next" to access basic settings page to configure language and display time. Set time zone and system time.
3. Click on "Next" to access network settings page to set up IP address, subnet mask and gateway.
4. Click on "Next" to access HDD management page to set up HDD array and HDD full strategy.
5. Click on "OK" to finish setup.

### LOGIN

Input the username and password to login or click on the menu button  in the lower left corner of the page to login. The factory default username is "admin", the password is "admin". Users have to login again if timeout without operations. Password change recommended after initial login.

After logging in the GVR3550 local page, users could click right mouse and then select any item in a pop-up menu to bring up the GVR3550 login page.

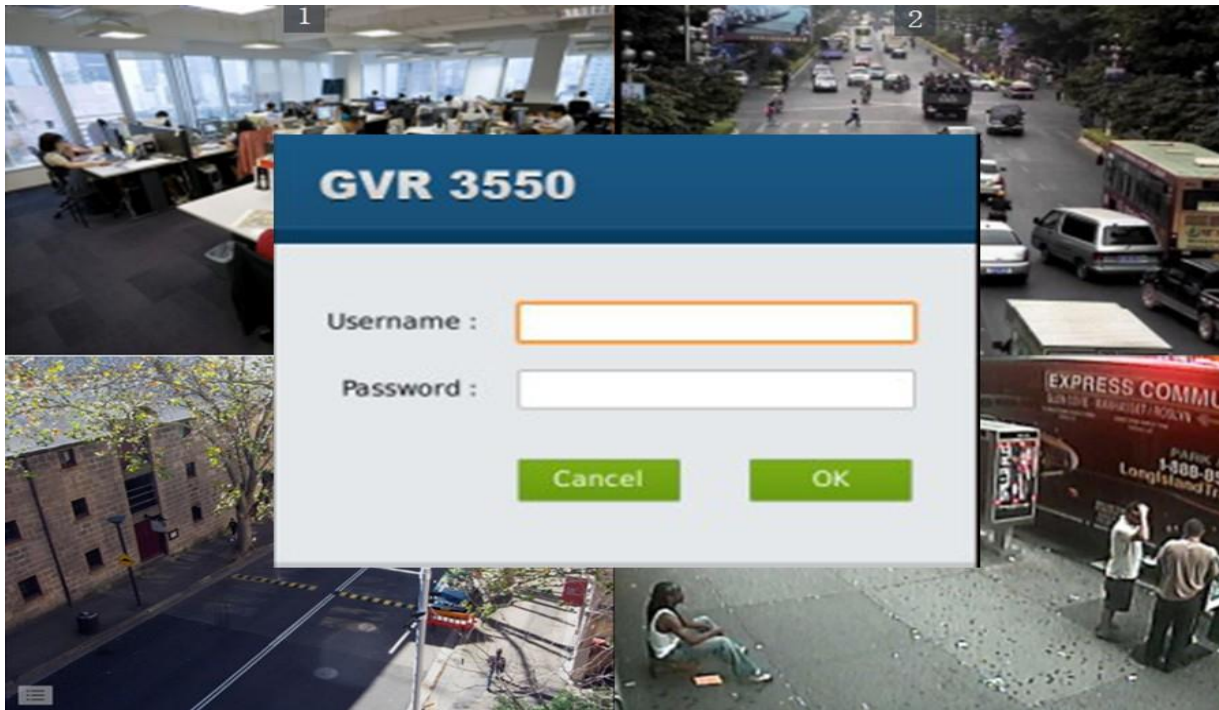

**Figure 13: GVR3550 Local Login Page**

## **LOCAL VIEW**

The GVR3550 would directly enter live view screen after boots up, users could check the preview screen without login but unable to make any operations. Only after logged in users could make basic view operations and other setups.

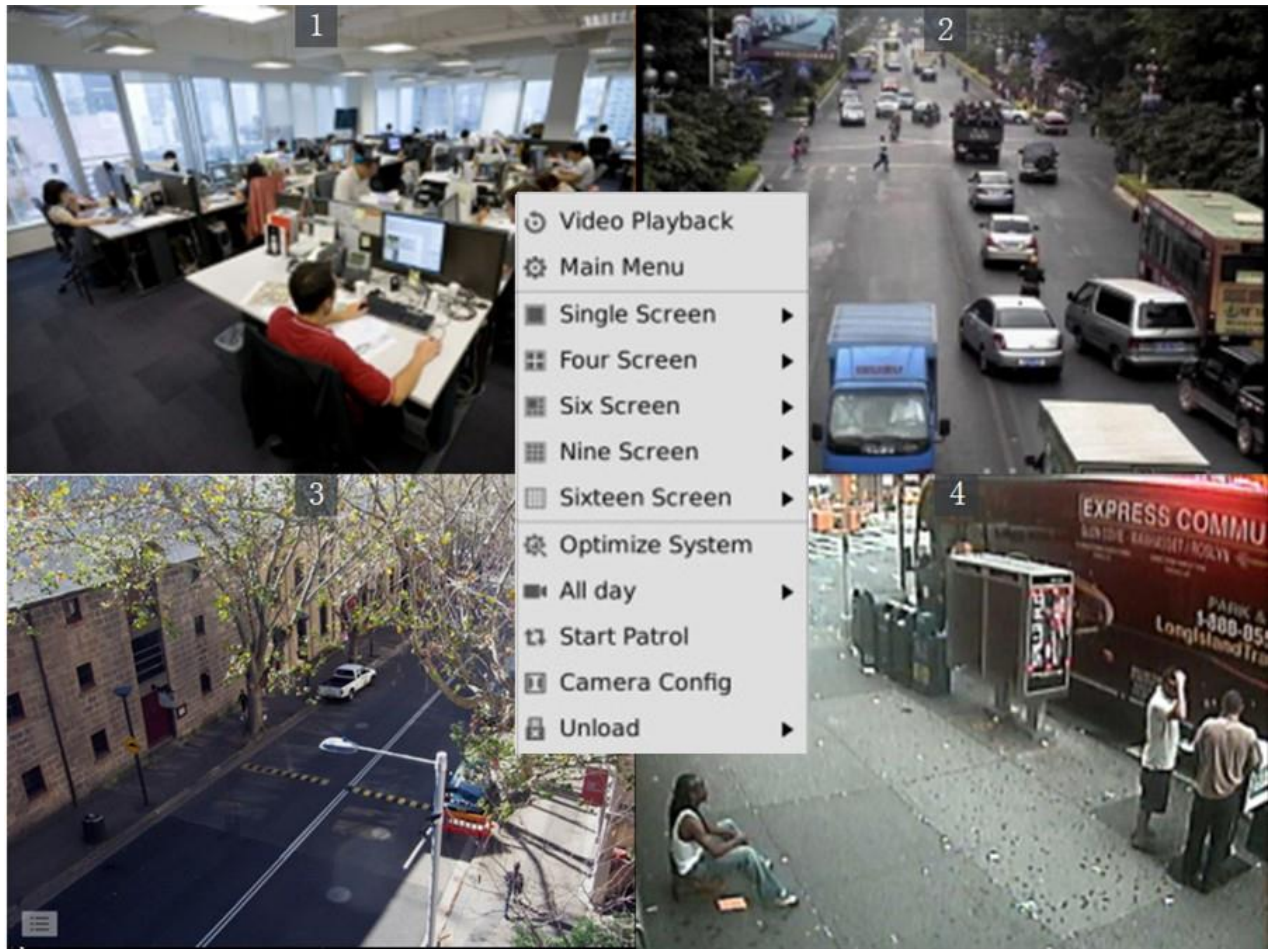









**Figure 14: GVR3550 Live View Page – Right Click Menu**

### **VIEW STATUS**

Preview camera status: The camera has not been added, camera preview, connecting the camera, camera connection failed.

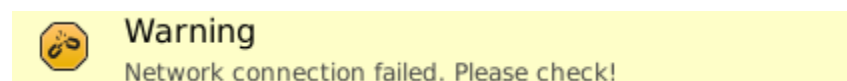

**Table 9: GVR3550 Preview Status Explanation:**





Icon	Name	Explanation
	<b>Motion Detection Alarm</b>	Alarm when detecting dynamic motion.
	<b>Camera Lens Occlusion Alarm</b>	Alarm in the corresponding camera when the remote camera is obscured.
	<b>Missing Object Alarm</b>	Alarm in the corresponding camera according to the alarm settings if the remote camera supports missing object alarm and local missing object alarm has been configured before.
	<b>Foreign Object Alarm</b>	Alarm in the corresponding camera according to the alarm settings if the remote camera supports missing object alarm once local foreign object alarm has been configured before.
	<b>I/O Alarm</b>	Alarm when the remote camera is connected to IO alarm device according to the alarm settings.
	<b>Record</b>	The monitoring camera is in record mode.
	<b>Add Camera</b>	If there is no existing camera, click this button to quick enter the camera settings page to add camera.
--	<b>Camera View</b>	Live view camera.
	<b>Camera connection Failed</b>	Failed to connect the related IP Cameras.
	<b>Video Decoding Failed</b>	It may be caused by protocol not supported, too large resolution and exceeded the decoding ability.

On the preview page, the record and alarm status of each camera could be distinguished by the tag on the top right corner of each camera.

A dialog box will pop up in the center screen to prompt the users if there is an abnormal alarm, as shown in figure below, the prompt box would disappear in 3 seconds.



**Table 10: GVR3550 System Abnormal Alarm Screen Explanation:**

Icon	Name	Explanation
	<b>Disconnection Alarm</b>	Alarm when the network is disconnected.
	<b>HDD Empty Alarm</b>	Alarm when no HDD detected.
	<b>HDD Error Alarm</b>	Alarm when HDD is abnormal.
	<b>HDD Full Alarm</b>	Alarm when HDD is full.
	<b>IP Conflict Alarm</b>	Alarm when detecting the IP address of another device is in conflict with the GVR in the network.







### **BASIC VIEW OPERATION**





Users could put the cursor on one camera screen if needs to make basic operations to a particular camera. Click to bring up the menu bar as shown in Figure 15. Click the buttons on the menu bar to make corresponding operations.



**Figure 15: GVR3550 Basic View Operation**

**Table 11: GVR3550 Basic View Operation Explanation:**

#	Icon	Name	Explanation
1		<b>Close Record</b>	The camera is not recording now
		<b>Auto Record</b>	The camera is in schedule record mode
		<b>Manual Record</b>	The camera is in manual record mode
2		<b>Capture</b>	The external storage devices (USB) need to be connected first. Users could configure the save path and set it to default
3		<b>Mute/Unmute</b>	When the volume in on, if the remote camera is installed with audio input device, users could listen in to the remote party
4		<b>Start /Stop Intercom</b>	When the intercom in on, if the remote camera is installed with audio output device, users could speak to the remote camera via local audio input device.
5		<b>PTZ Control</b>	Click to enable PTZ control to configure PTZ preset, patrol and pattern

6		<b>Switch to Full Screen</b>	Switch the current screen to full screen or double click to enter full screen mode. Click  or double click the screen to exit full screen.
7		<b>Instant Playback</b>	Playback the record in the preset time. It will prompt "The selected camera has no record "if has no existing record. Users could set the preset time in <b>Basic System Settings</b> chapter
8		<b>Image Config</b>	Enter the corresponding setting page to adjust the current window image.
9		<b>Encode Config</b>	Open interface to configure encoding parameters of IP Camera



**NOTE:**

- *Start intercom will unmute the camera the same time. Close the intercom to mute the camera.*
  - *When start intercom of one camera, if another camera has enabled intercom or unmute, turn off it first then start intercom of the current camera.*
  - *If one camera has enabled intercom or unmute, unmute another camera will close intercom/unmute the previous camera automatically.*
-

## IMAGE CONFIG

Click on the image config button  to bring up the dialogue box as shown in Figure 16.

Users could adjust brightness, contrast, saturation and hue by clicking the corresponding Plus/Minus icon or click  button to access editing mode.

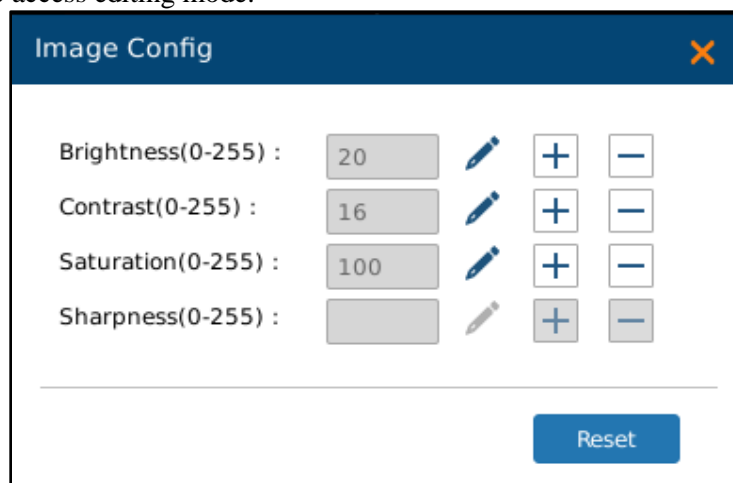

**Figure 16: GVR3550 Image Config Page**

## PTZ CONTROL

Click the PTZ control button  to bring up the PTZ control interface, as shown in Figure 17 below.



**Figure 17: GVR3550 PTZ Control Page**

**Table 12: GVR3550 PTZ Control Parameter Explanation:**

#	Name	Explanation
1	<b>PTZ Direction Control and Reset Button</b>	8 PTZ direction buttons to control the corresponding eight PTZ directions, the reset button to restore PTZ direction to the original position
2	<b>Iris+</b>	Increasing Iris
3	<b>Focus+</b>	Increasing the Focus
4	<b>Zoom+</b>	Increasing zoom. Only available in full screen mode.
5	<b>Iris-</b>	Reducing Iris
6	<b>Focus-</b>	Reducing the Focus
7	<b>Zoom-</b>	Reducing zoom. Only available in full screen mode.
8	<b>Step</b>	Step used to control PTZ controller moving speed, e.g.: Step 8 will be much faster at moving compared to Step 1. (The number can be adjusted by mouse or front panel keypad)
9	<b>More</b>	Opening more PTZ Control parameters
10	<b>PZT Control Selection</b>	<ul style="list-style-type: none"> <li>When set PTZ to preset, bring up preset setting interface and operation panel below the screen.</li> <li>When set PTZ to patrol, bring up patrol setting interface and operation panel below the screen.</li> </ul> <p>When set PTZ to pattern, bring up contrail setting interface and operation panel below the screen</p>
11	<b>Exit</b>	Click to exit the PTZ control interface directly



**NOTE:**



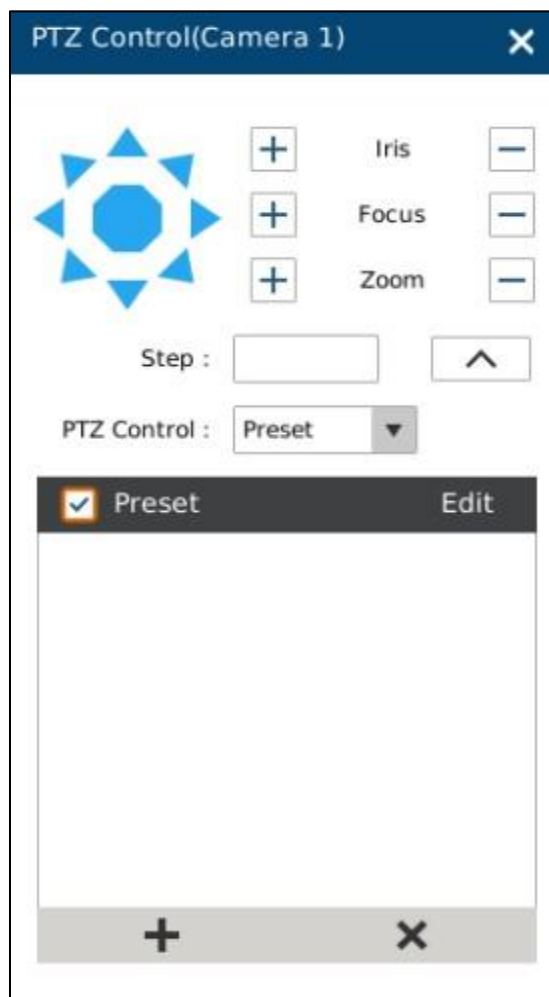

- *The GVR3550 only supports PTZ control with ONVIF Protocol, the IP camera should be properly connected and the PTZ device should be configured. Please make sure the RS-485 cable between the PTZ decoder and the IP camera is connected correctly.*

## PRESET

When set PTZ to preset, users could add/delete/edit preset on the control panel below. The procedures are shown in Figure 18.



**Figure 18: GVR3550 PTZ Control Page – Preset**

1. Adjust the remote camera position via the PTZ steering control.
2. Click on  to add a new preset.
3. Enter the preset name in the input box or just use the default name.
4. Click the check button  to save the preset, or click on  on the right side of the preset to edit the name.
5. Double click one preset with mouse (or press the OK button on the front panel, or press the ENTER button on the remote control) to activate it.
6. Users could click  below the preset control panel to delete the preset.

## PATROL

When set PTZ to patrol, users could edit and use patrol path on the control panel. The factory default setting is 4 empty patrol paths. See Figure 19.

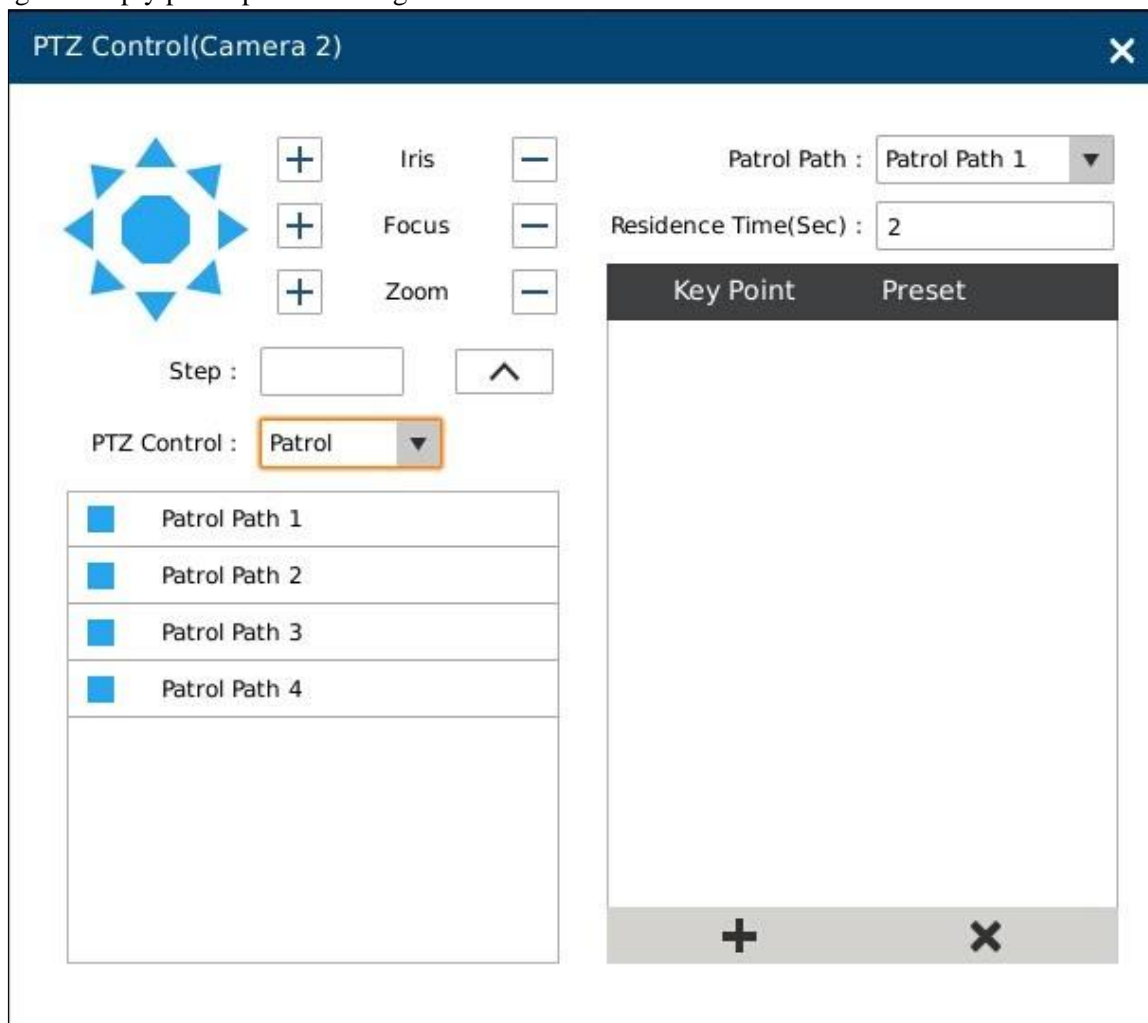





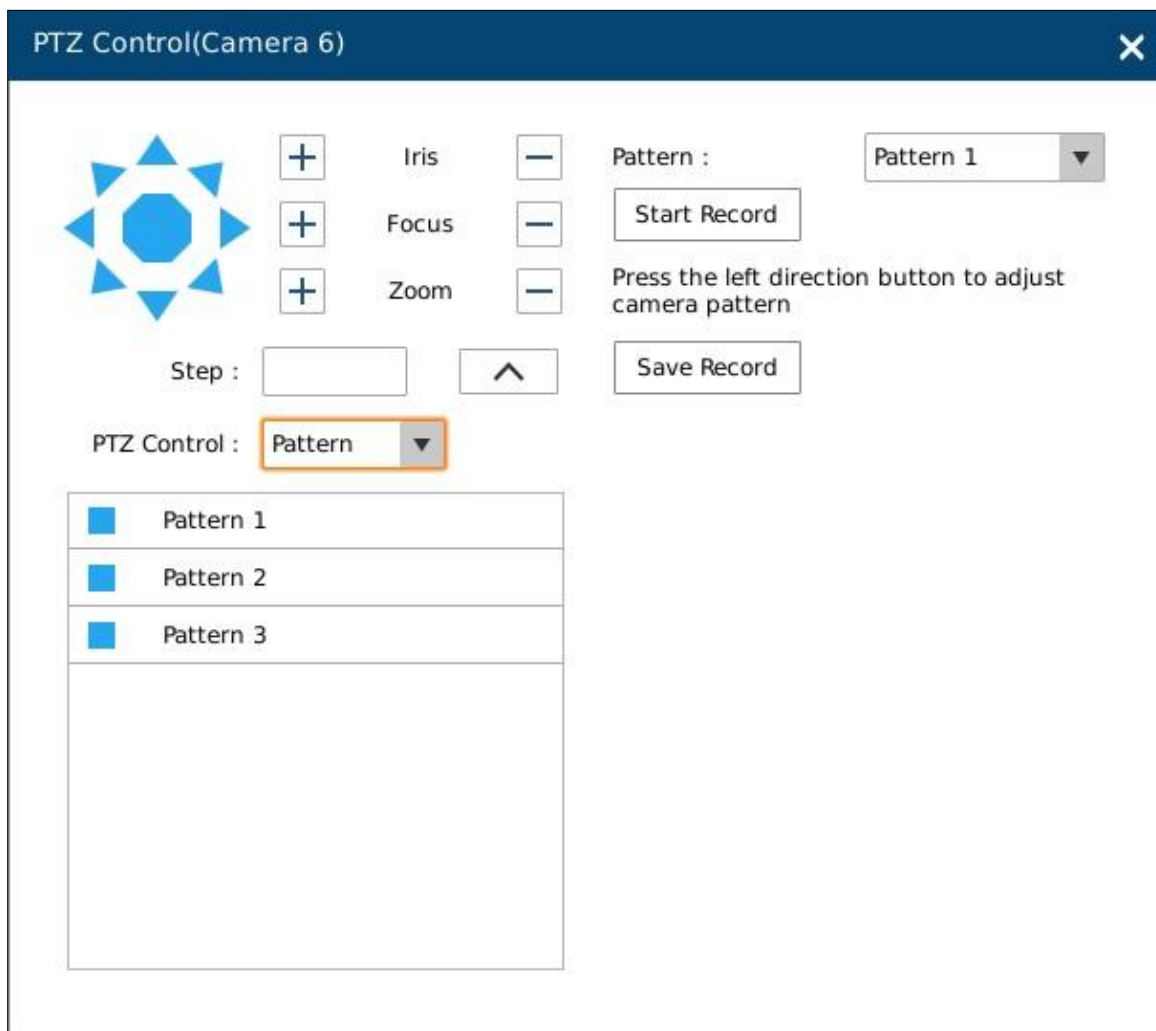

Figure 19: GVR3550 PTZ Control Page – Patrol



1. Set PTZ to patrol.
2. Select the patrol path.
3. Set the residence time the patrol path stays at each preset.
4. Click on  to add key point and set it as one preset. Users could click on  in the lower right corner of the panel to delete the preset.
5. Click on  before the patrol path, when it turns to a triangle , the PTZ will cycle according to the path. Click  again to stop the patrol.

## PATTERN

When set PTZ to pattern, users could edit and use pattern on the control panel. The factory default setting is 3 empty patterns. See Figure 20.



**Figure 20: GVR3550 PTZ Control Page – Pattern**

1. Set PTZ control to pattern
2. Select the pattern name.
3. Click the "Start Record" button to adjust the remote camera pattern via the PTZ steering control.
4. Click the "Save Record" button save the pattern.
5. Click on  before the pattern, when the button turns to a triangle , the PTZ will cycle according to the pattern. Click  again to stop PTZ movement.



## RIGHT-CLICK

Click the right mouse to bring up the right-mouse menu, users could enter Record Playback or the Main Menu, Start/Stop All record, Start/Stop Patrol, or unload the inserted USB device. The local screen can be set to Single Screen and Four Screen, users need to set the specified cameras respectively.

When inserted USB storage device to export data, users could see the "Unload" option in the right-click menu. Put the cursor on "Unload" and select "Unload USB" to unplug it once the data export is completed.

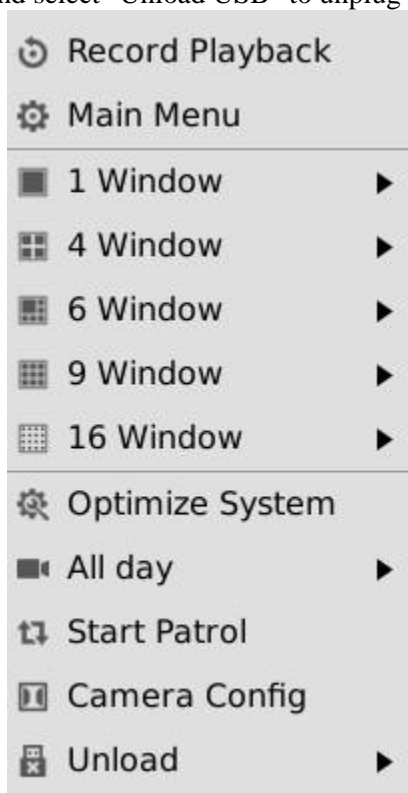

**Figure 21: GVR3550 Right Click Mouse Menu**

**Table 13: GVR3550 Right Click Mouse Menu Parameter Explanation:**

#	Name	Explanation
1	<b>Record Playback</b>	Enter Record Playback page
2	<b>Main Menu</b>	Enter device system setting page
3	<b>Single Screen</b>	Switch to one camera to preview
4	<b>Four Screen</b>	Switch to 4 screen: IMG One-to-Four, IMG Five-to-Eight, IMG Nine-to-Twelve, IMG Thirteen-to-Sixteen, IMG Seventeen-to-Twenty, IMG Twenty-one-to-Twenty-four
5	<b>Six Screen</b>	Switch to 6 screen: IMG One-to-Six, IMG Seven-to-Twelve, IMG Thirteen-to-Eighteen, IMG Nineteen-to-Twenty-four

6	<b>Nine Screen</b>	Switch to 9 screen: IMG One-to-Nine, IMG Ten-to-Eighteen, IMG Nineteen-to-Twenty-four
7	<b>Sixteen Screen</b>	Switch to 16 screen: IMG One-to-Sixteen, IMG Seventeen-to-Twenty-four
8	<b>Optimize System</b>	Automatically adjust the camera connection protocol and secondary stream resolution, bit rate, frame rate and related parameters. Reboot after the completion
9	<b>Start/Stop All Day Record</b>	Start All Manual Record. Once enabled, the menu item turns to "Stop All Record". Click to stop all record including auto record
10	<b>Start/Stop Patrol</b>	Enable Patrol. Once enabled, the menu item turns to " Stop Patrol". Click to stop patrol then stay on the current screen.
11	<b>Camera Config</b>	Quick access the camera settings
12	<b>Unload</b>	Unload the inserted USB device



**NOTE:**

- *Please go to Menu->System Settings->Local View Control to set Patrol Intervals before apply Start Patrol.*
- *Patrol would pause if users make any arbitrary operations in the process of patrol, abort the operations to resume patrol.*

**SHORTCUT BUTTON**

Click on the shortcut button in the lower left corner of the preview screen to bring up the shortcuts options as shown in Figure 22. Users can enter the playback page or the main menu, login /logout or reboot the unit.

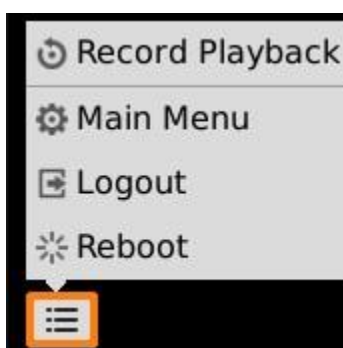

**Figure 22: GVR3550 View Page Shortcut Button Menu**

## LOCAL PLAYBACK

Click right mouse and select Record Playback to enter the playback page, as shown in Figure 23 below. Users could make operations to record like Search, Playback, Tagging, Start Clipping, etc.

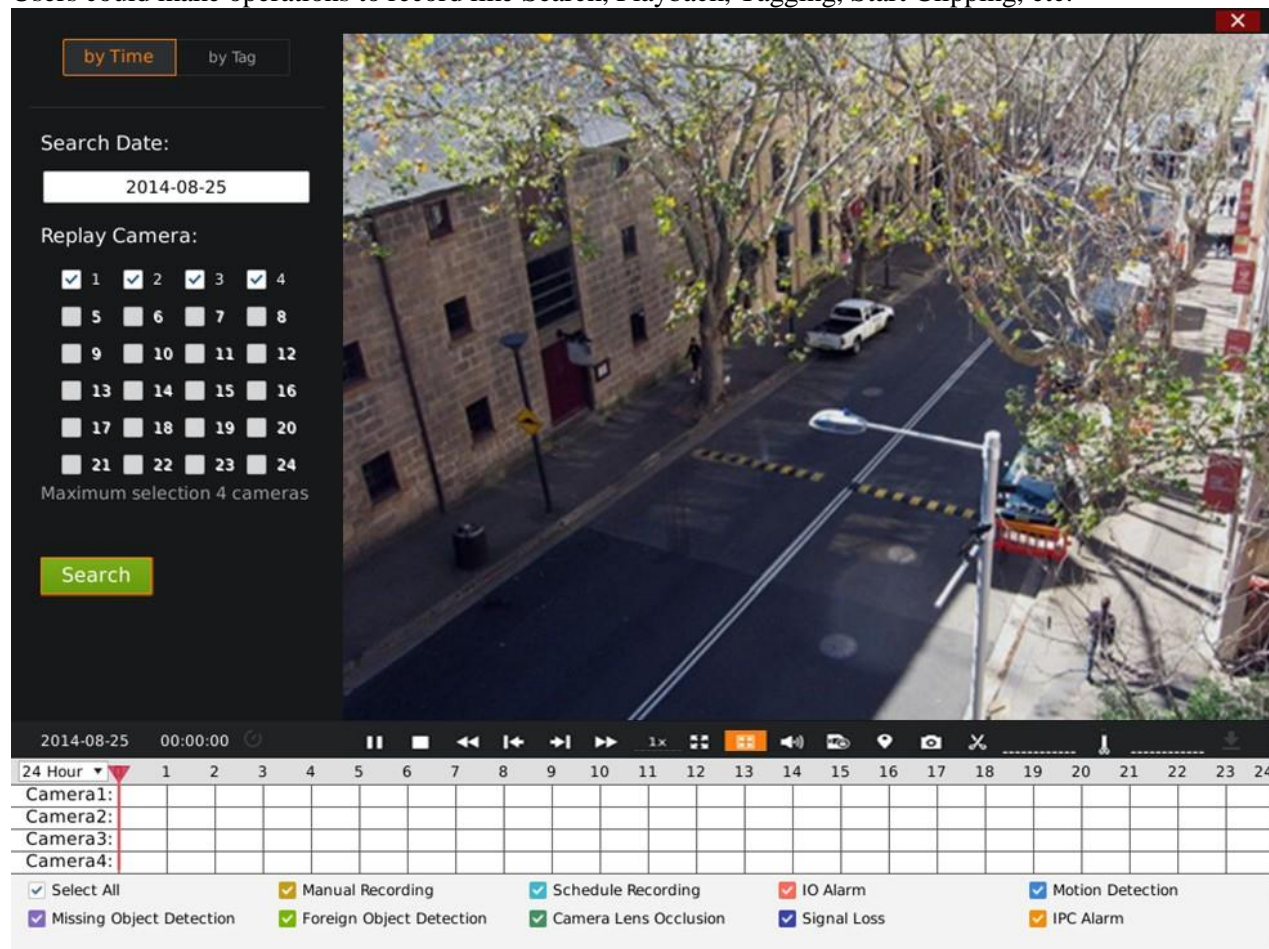

**Figure 23: GVR3550 Record Playback Page**

## SEARCH RECORD

Users could search record by time and by tag.

### SEARCH BY TIME

Select Record camera (up to 4 cameras) after selecting the record date, and then click the "Search" button to search. The searched record would be displayed in the record status toolbar below the playback page.

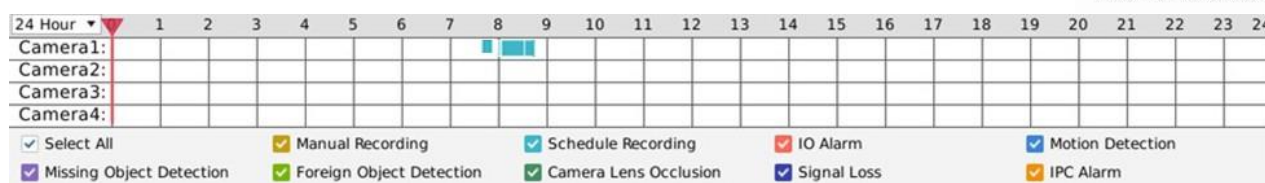

**Figure 24: GVR3550 Record Playback – Record Status Toolbar Page**

There are color descriptions about the record status on the bottom. As Figure 24 shows, the priority of color display is from left to right, from highest to lowest. (Except for "Select All"). Select "by Time" and click the check boxes of different colors to set whether to display the corresponding record.

**Table 14: GVR3550 Recording Status Parameter Explanation:**

Icon	Name	Explanation
<input checked="" type="checkbox"/>	<b>Select All</b>	Display all types of recording
<input checked="" type="checkbox"/>	<b>IO Alarm</b>	IO alarm record file
<input checked="" type="checkbox"/>	<b>IO Alarm (IPC)</b>	Remote IO alarm record file (IP Camera)
<input checked="" type="checkbox"/>	<b>Motion Detection</b>	Motion detection record file
<input checked="" type="checkbox"/>	<b>Missing Object Detection</b>	Missing object detection record file
<input checked="" type="checkbox"/>	<b>Foreign Object Detection</b>	Foreign object detection record file
<input checked="" type="checkbox"/>	<b>Camera Lens Occlusion</b>	Camera occlusion record file
<input checked="" type="checkbox"/>	<b>Video Loss</b>	Video Loss file
<input checked="" type="checkbox"/>	<b>Manual Record</b>	Manual record file
<input checked="" type="checkbox"/>	<b>Schedule Record</b>	Schedule record file

## SEARCH BY TAG

Select "by Tag" and input the keyword in the search query box, click "Search" to bring up the page as shown in Figure 25 Click  to playback.

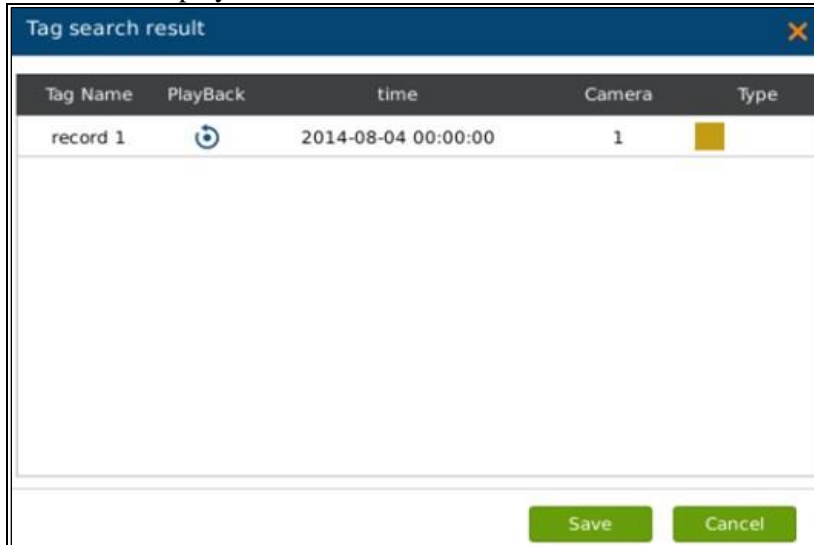

Figure 25: GVR3550 Record Playback – Record Status Toolbar Page

Click "Tag Management" button to access the Tag Management page as shown in Figure 26, users could edit or delete tag(s).

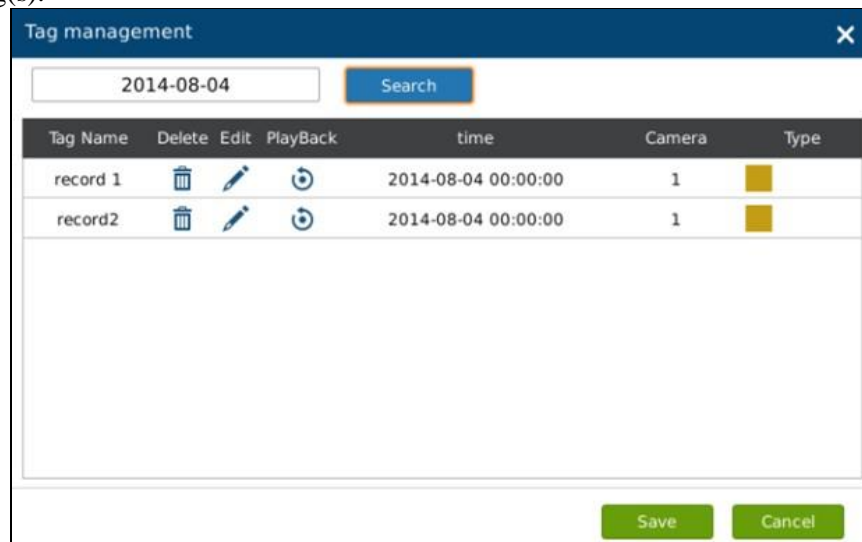

Figure 26: GVR3550 Tag Management Page



### NOTE:

- When HDD is full, the corresponding tag will be deleted

## RECORD PLAYBACK













GVR3550 support synchronous 4 channels playback, users can specify the camera and playback date, or make operations like Rewind, Single Frame Rewind/ Forward, Full Screen/Cancel Full Screen, Capture, Lock Record, Tagging, lock Record, etc.









The playback toolbar is shown in Figure 27.

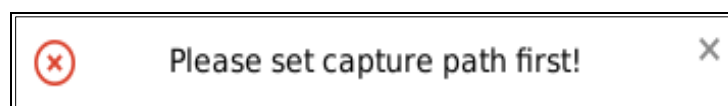

Figure 27: GVR3550 Record Playback Toolbar

Table 15: GXV3550 Record Playback Toolbar Explanation:

Icon	Name	Explanation
	Manual Set Time	Click to enter the time setting page to set when to play the record.
	Play/Pause	Play/pause record.
	Stop	Stop playing record.
	Rewind.	Play backward at certain speed, only available when in full screen.
	Single Frame Rewind	Single frame play backward, only available when in full screen.
	Single Frame Forward	Single frame play forward, only available when in full screen.
	Speed Adjustment	To speed up the record, support 2 times, 4 times, 8 times and 16 time, 1 time, 1/2 time, 1/4 time, 1/8 time and 1/16 time fast forward. Only available when in full screen.
	Full screen	Select camera to enter full screen mode. Click the screen to bring up the toolbar on the bottom of screen. The mouse located outside the toolbar without any operations in three seconds would be hidden automatically.
	Capture	Snapshot the current screen and save the image to the external storage device. If the capture failed, a prompt will be shown as in Figure 28. Please insert the USB device then go to Main Menu->System Settings->Basic System Settings to set the save path
	Volume	Click the button to bring up the volume control bar, drag it to adjust the volume. Click the button again to close the control bar.
	Tagging	Click the button to bring up the tagging setting page as shown in Figure 29. Fill in the "Tag Name" input box and then click the "Save" button.
	1 Window.	Click a screen to display.

	<b>4 Window.</b>	Click to enter 4 window .
	<b>Get Locked Recording.</b>	Click the button to enter Locked Recording page as shown in Figure 30. Users could view all records and the locked records on certain day. Click on  to lock record and the locked record is labeled with icon  , click on  to unlock the record. Users could also click on the playback button  to playback the record.
	<b>Start Clipping</b>	Click the button to set the play time as start clipping time.
	<b>End Clipping.</b>	Click the button to set the play time as end clipping time.
	<b>Download Clippings</b>	Click the button to bring up the record save path Setting page as shown in Figure 31 below. Click on the "Save" button to download record after setting the path.



**Figure 28: GVR3550 Save Snapshot Failed Prompt**

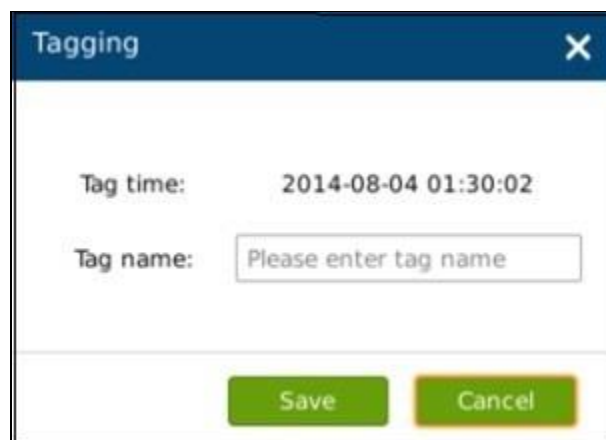

**Figure 29: GVR3550 Tagging Management**

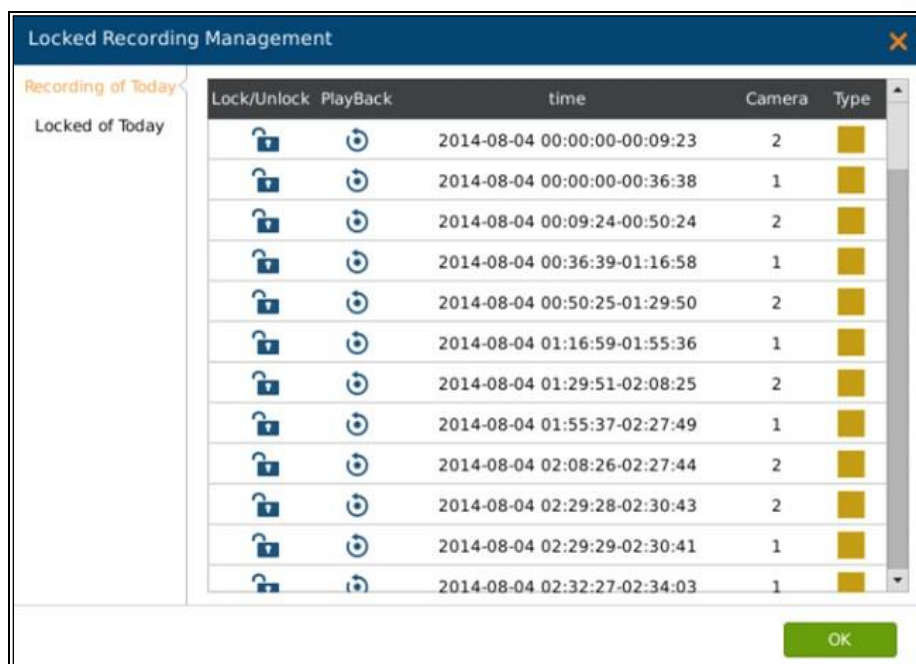

The screenshot shows a window titled "Locked Recording Management" with a close button (X) in the top right. On the left, there is a sidebar with "Recording of Today" and "Locked of Today" sections. The main area contains a table with the following columns: "Lock/Unlock", "PlayBack", "time", "Camera", and "Type". The table lists 12 recording entries for the date 2014-08-04, each with a lock icon, a play button, a time range, a camera ID, and a yellow status box.

Lock/Unlock	PlayBack	time	Camera	Type
		2014-08-04 00:00:00-00:09:23	2	
		2014-08-04 00:00:00-00:36:38	1	
		2014-08-04 00:09:24-00:50:24	2	
		2014-08-04 00:36:39-01:16:58	1	
		2014-08-04 00:50:25-01:29:50	2	
		2014-08-04 01:16:59-01:55:36	1	
		2014-08-04 01:29:51-02:08:25	2	
		2014-08-04 01:55:37-02:27:49	1	
		2014-08-04 02:08:26-02:27:44	2	
		2014-08-04 02:29:28-02:30:43	2	
		2014-08-04 02:29:29-02:30:41	1	
		2014-08-04 02:32:27-02:34:03	1	

An "OK" button is located at the bottom right of the window.

Figure 30: GVR3550 Locked Recording Management Page

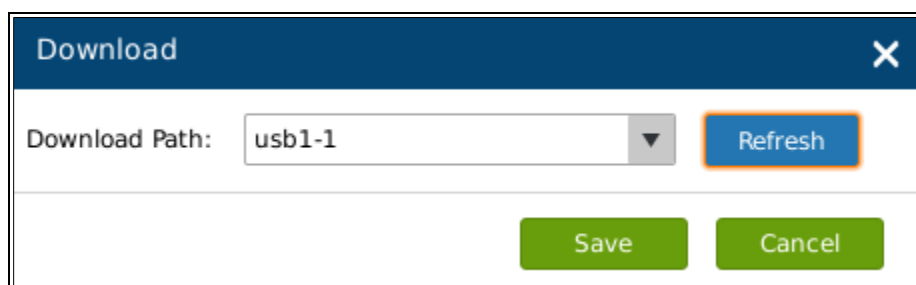

The screenshot shows a "Download" dialog box with a close button (X) in the top right. It features a "Download Path:" label followed by a dropdown menu currently showing "usb1-1". To the right of the dropdown is a blue "Refresh" button. At the bottom of the dialog are two green buttons: "Save" and "Cancel".

Figure 31: GVR3550 Recording Save Path Setting Page



**NOTE:**

- The configured default path would be invalid if the external storage device is changed, the corresponding failure prompt would pop up if users click the "Capture" or "Download" button. Users could go to Main Menu->System Settings->Basic System Settings to set the default path to save snapshots and download file.
- Please do not disconnect the USB device when downloading the clippings files or it may cause download failure or error.
- Users could click  to set time range: 3 hours, 6 hours or 12 hours. Click one time slot to replay the record.
- Click the Record File with time bar can start playback video recording at that time frame.



# MAIN MENU

Right click the mouse to enter the GVR3550 main menu page, see Figure 32.

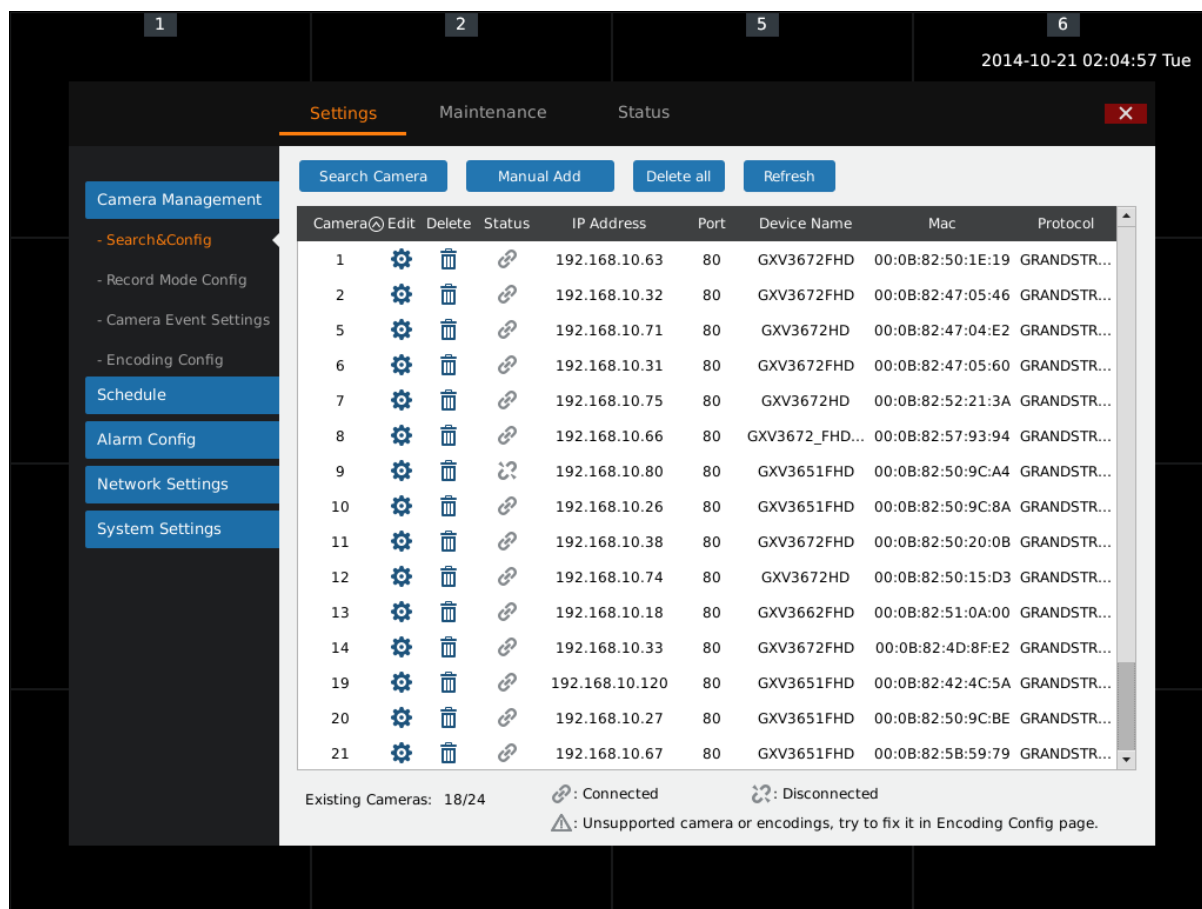

The screenshot displays the GVR3550 main menu page. At the top right, the date and time are shown as 2014-10-21 02:04:57 Tue. The page is divided into three tabs: Settings (selected), Maintenance, and Status. Below the tabs, there are four buttons: Search Camera, Manual Add, Delete all, and Refresh. A table lists 21 cameras with columns for Camera ID, Edit, Delete, Status, IP Address, Port, Device Name, Mac, and Protocol. The table shows various camera models like GXV3672FHD and GXV3651FHD. At the bottom, it indicates 'Existing Cameras: 18/24' and provides a legend for connection status: a chain link icon for 'Connected' and a broken chain link icon for 'Disconnected'. A warning icon and text state: 'Unsupported camera or encodings, try to fix it in Encoding Config page.'

Camera	Edit	Delete	Status	IP Address	Port	Device Name	Mac	Protocol
1	⚙️	🗑️	🔗	192.168.10.63	80	GXV3672FHD	00:0B:82:50:1E:19	GRANDSTR...
2	⚙️	🗑️	🔗	192.168.10.32	80	GXV3672FHD	00:0B:82:47:05:46	GRANDSTR...
5	⚙️	🗑️	🔗	192.168.10.71	80	GXV3672HD	00:0B:82:47:04:E2	GRANDSTR...
6	⚙️	🗑️	🔗	192.168.10.31	80	GXV3672FHD	00:0B:82:47:05:60	GRANDSTR...
7	⚙️	🗑️	🔗	192.168.10.75	80	GXV3672HD	00:0B:82:52:21:3A	GRANDSTR...
8	⚙️	🗑️	🔗	192.168.10.66	80	GXV3672_FHD...	00:0B:82:57:93:94	GRANDSTR...
9	⚙️	🗑️	🔗	192.168.10.80	80	GXV3651FHD	00:0B:82:50:9C:A4	GRANDSTR...
10	⚙️	🗑️	🔗	192.168.10.26	80	GXV3651FHD	00:0B:82:50:9C:8A	GRANDSTR...
11	⚙️	🗑️	🔗	192.168.10.38	80	GXV3672FHD	00:0B:82:50:20:0B	GRANDSTR...
12	⚙️	🗑️	🔗	192.168.10.74	80	GXV3672HD	00:0B:82:50:15:D3	GRANDSTR...
13	⚙️	🗑️	🔗	192.168.10.18	80	GXV3662FHD	00:0B:82:51:0A:00	GRANDSTR...
14	⚙️	🗑️	🔗	192.168.10.33	80	GXV3672FHD	00:0B:82:4D:8F:E2	GRANDSTR...
19	⚙️	🗑️	🔗	192.168.10.120	80	GXV3651FHD	00:0B:82:42:4C:5A	GRANDSTR...
20	⚙️	🗑️	🔗	192.168.10.27	80	GXV3651FHD	00:0B:82:50:9C:BE	GRANDSTR...
21	⚙️	🗑️	🔗	192.168.10.67	80	GXV3651FHD	00:0B:82:5B:59:79	GRANDSTR...

Figure 32: GVR3550 Main Menu Page

The configuration items are varied according to different user permissions. Administrator users can make operations like System Settings, Maintenance.

## CAMERA MANAGEMENT

Camera management includes Search& Configure, Record Mode Config, Camera Event Settings and Encoding Config.

### SEARCH/CONFIGURE CAMERA

Click on "Search Camera" to search out all available cameras within the same LAN as shown in Figure 33 below.

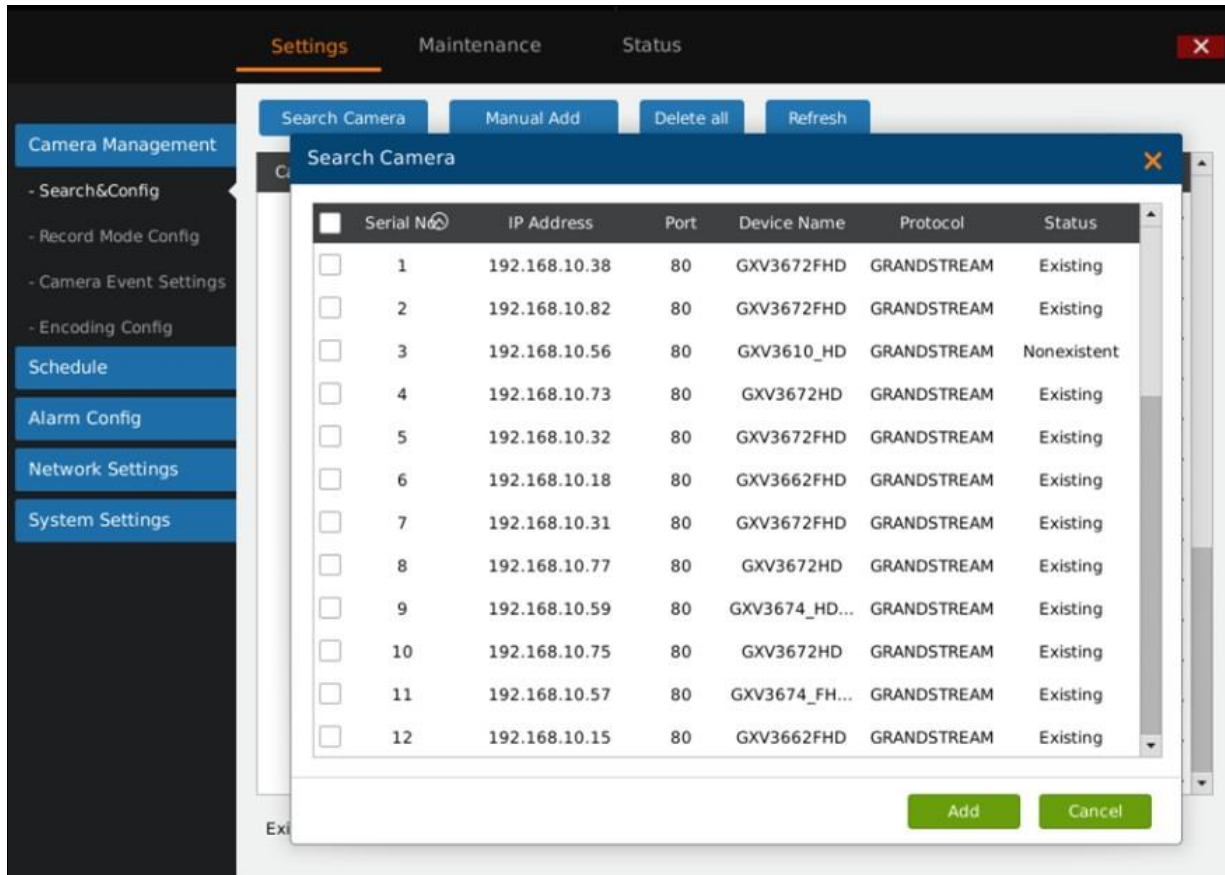

**Figure 33: GVR3550 Camera Management Setting Page**

Tick the camera and click on "Add" button to add it to the camera list.

If unable to search out the camera you need automatically, users could manual add the camera to the camera list. See Figure 34 below.



Figure 34: GVR3550 Manual Add Camera Page

Table 16: GVR3550 Camera Parameter Setting Explanation:

Parameter	Explanation
<b>Camera</b>	Set the camera No., existing camera number cannot be changed.
<b>Protocol</b>	Supports the Grandstream series cameras and cameras compatible with ONVIF protocol
<b>Protocol (IP)</b>	Set the protocol to TCP or UDP
<b>IP Address</b>	Set the IP address of the remote IP Camera
<b>Port</b>	Set the port number of the remote IP Camera
<b>Username</b>	Set the username to connect the remote IPC. The default is "admin"
<b>Password</b>	Set the password to connect the remote IPC. The default is "admin"



**NOTE:**

- *When trying to connect to the remote IPC, the username and password the GVR use are both "admin" or null by default. If the username and password are not default ones, the connection may fail. Please manual modify the remote IPC username and password.*

## RECORD MODE CONFIG

Record Mode Configuration page is as shown in Figure 35 below, users could click one camera to set Close Record, All Day Record and Schedule Record.

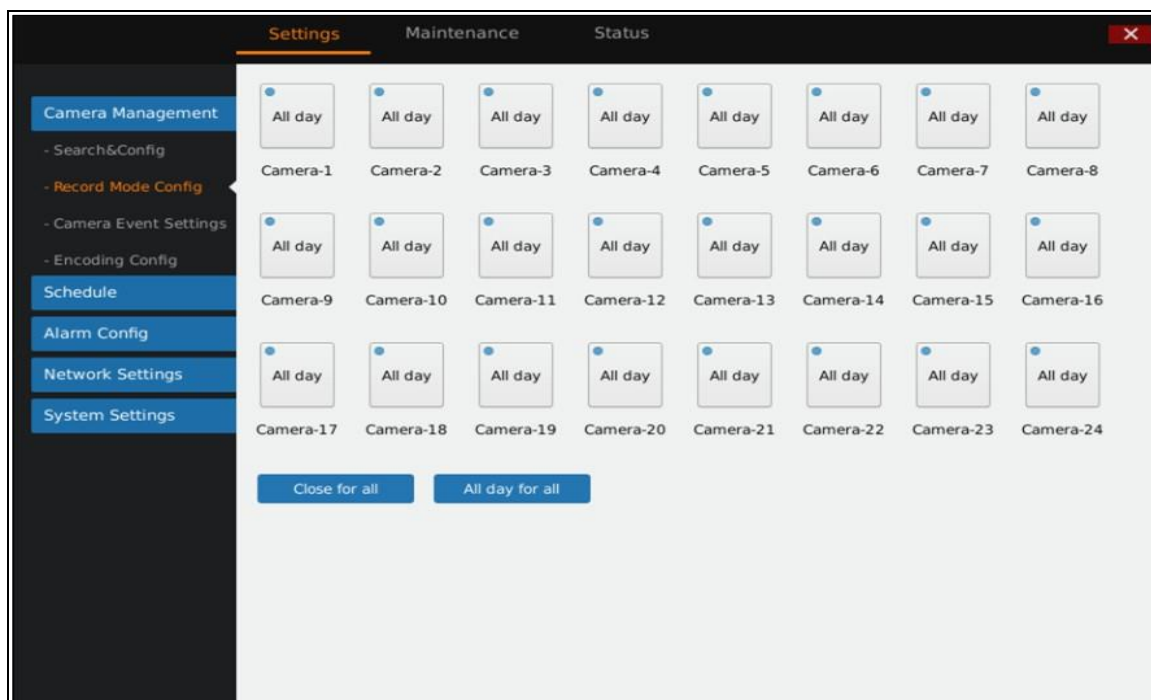
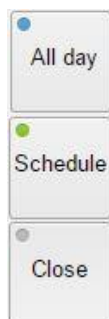



Figure 35: GVR3550 Record Mode Config Page



- **All day record Status:** Enable all cameras to record.
- **Auto Record Status:** Enable record via the camera.
- **Close Record Status:** Disable record via the current camera.

When set to "Schedule", users should select schedule in the drop-down list .Tap on  to add new schedule; Or tap on "Close for All" or "All Day for All" to set cameras.

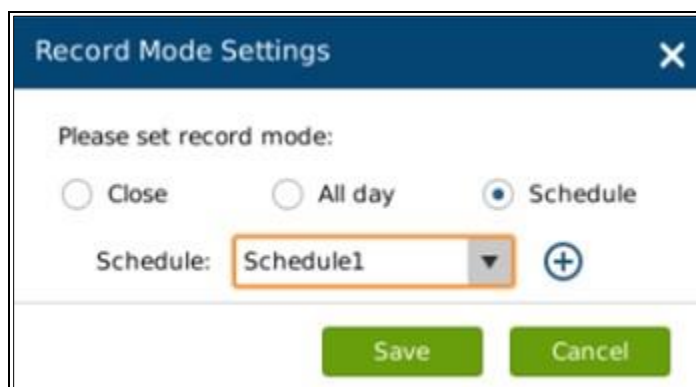

Figure 36: GVR3550 Record Mode Setting Page

## CAMERA EVENT SETTINGS

Camera event settings page is as shown in Figure 37 below, users could set different Alarm type to each camera.

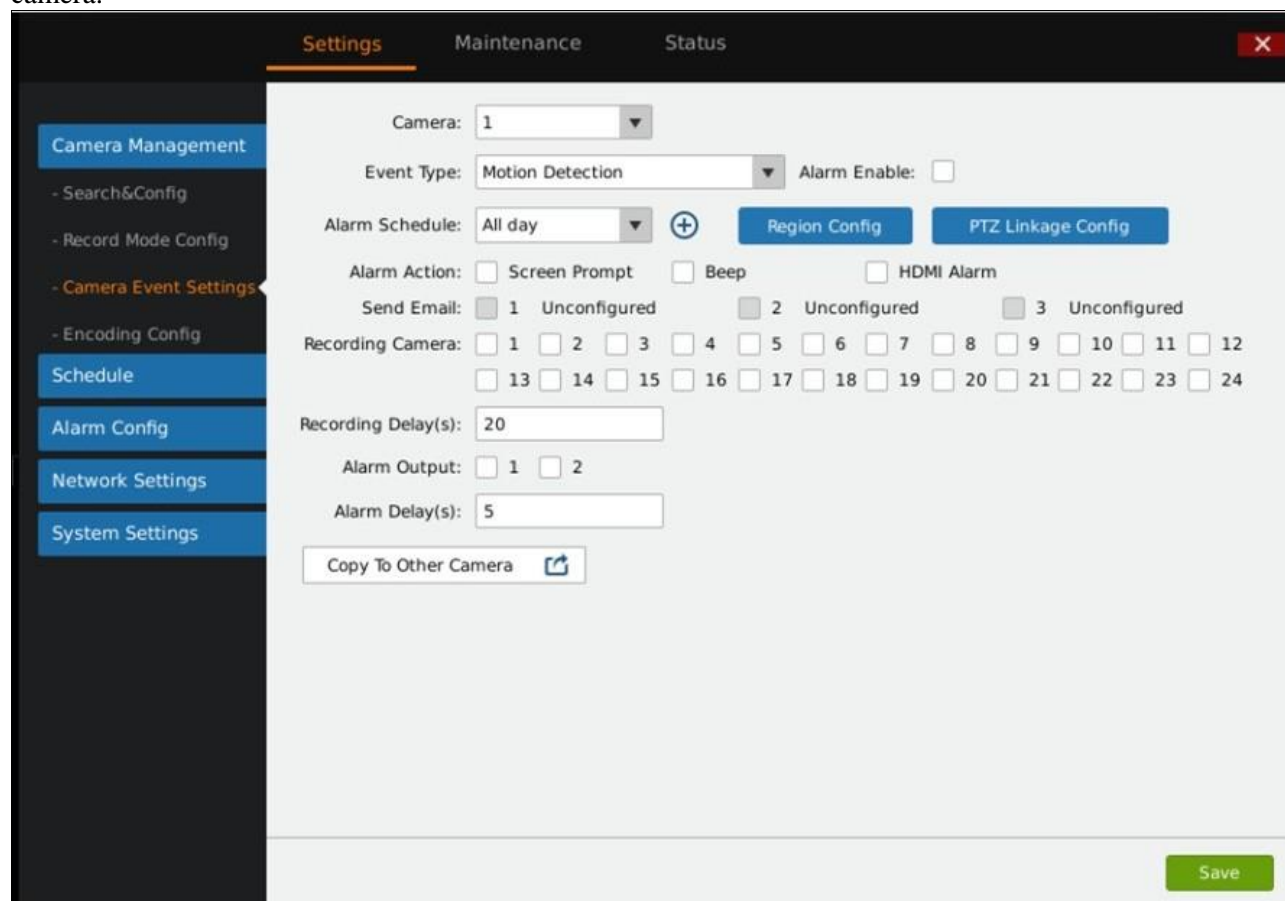

Figure 37: GVR3550 Camera Event Setting Page

**Table 17: GVR3550 Camera Events Settings parameters Explanation**

Parameter	Explanation
<b>Camera</b>	Select the camera user would like to configure
<b>Event Type</b>	Motion Detection, Camera Lens Occlusion, Signal Loss, IPC External Alarm, Missing Object Detection, Foreign Object Detection.
<b>Alarm Enable</b>	Tick to enable/unable alarm.
<b>Alarm Schedule</b>	Select schedule in the drop-down list .
<b>Region Config</b>	Set detection area to IPC with Motion Detection, Missing Object Detection and Foreign Object Detection function. Users could set up to 16 detection areas. Move the mouse to add areas and click on X in the upper right corner of the area to delete it. Double click or right click the mouse to save the area and exit.
<b>PTZ Linkage Config</b>	Only available to IPC with PTZ linkage function. For different IPC and camera alarm event, users could set various alarm action: Screen Prompt, Beep, HDMI Alarm, Send Mail, Alarm Output, Alarm Delay(s).Or copy the alarm action to other cameras.
<b>Alarm Action</b>	Set different alarm mode.

**Table 18: GVR3550 Camera Alarm Parameter Explanation:**

Parameter	Explanation
Screen Remind	Click to send alarm to display screen
Beeping	Click to beeping when alarm triggered
HDMI Alarm	Click to send alarm to GVR3550 connected HDMI display device
Email Notification	Click to send email to configured email. Email Configuration: Main Menu → Settings → System Settings → Email Settings
IP Camera	Click to select related alarm IP Cameras
Record Delay (Second)	Configure the time for alarm recording
Alarm Output	Click to select Alarm Output
Alarm Delay (Second)	Configure Alarm Delay Timer (in Second)
Copy to other IPC	Click to copy the alarm configuration to other IP cameras.

## ENCODING CONFIG

Encoding Config page is as shown in Figure 38 below, users could configure camera's name and stream. There are two streams. One is primary stream that is used for Play Black, another is secondary stream which is used for Live View.

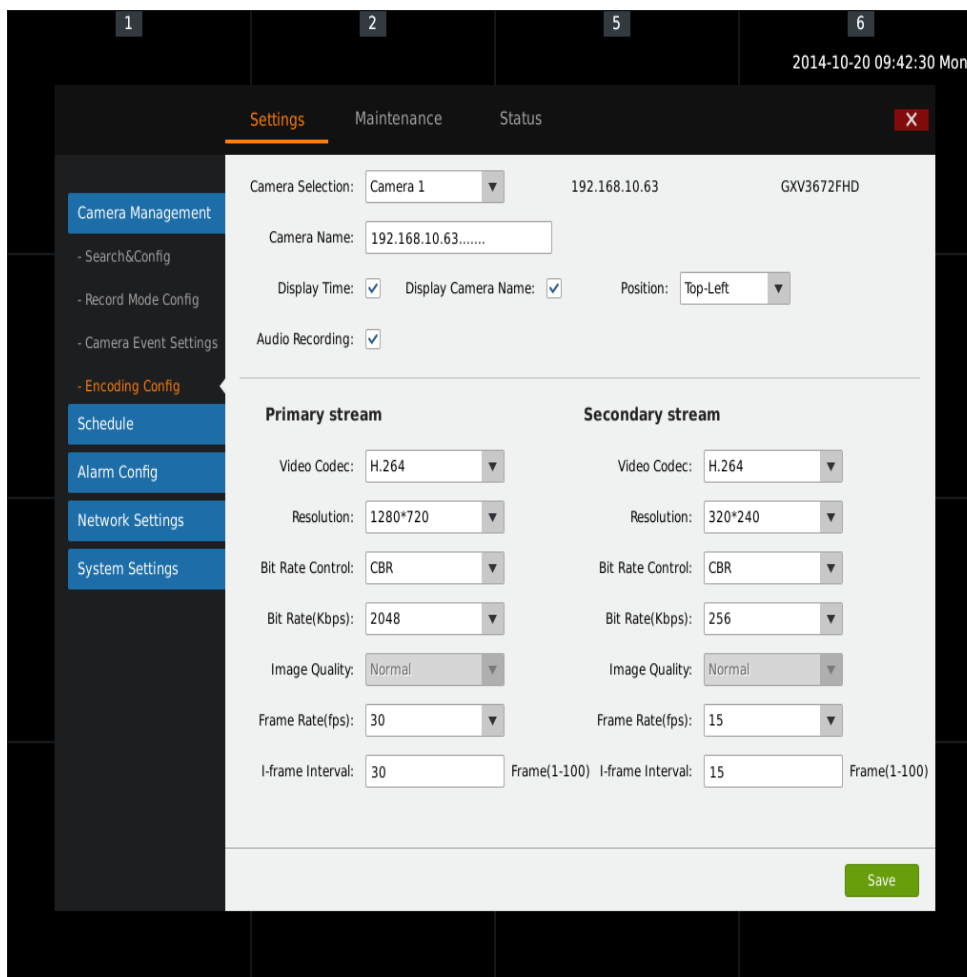

The screenshot shows the 'Encoding Config' page for a camera. The page is divided into several sections:

- Header:** Shows the date and time '2014-10-20 09:42:30 Mon' and navigation tabs for 'Settings', 'Maintenance', and 'Status'.
- Left Sidebar:** Contains navigation options: 'Camera Management', 'Search&Config', 'Record Mode Config', 'Camera Event Settings', 'Encoding Config' (highlighted), 'Schedule', 'Alarm Config', 'Network Settings', and 'System Settings'.
- Main Content Area:**
  - Camera Selection:** A dropdown menu set to 'Camera 1', displaying the IP '192.168.10.63' and model 'GXV3672FHD'.
  - Camera Name:** A text input field containing '192.168.10.63.....'.
  - Display Options:** Checkboxes for 'Display Time' and 'Display Camera Name' are both checked. A 'Position' dropdown is set to 'Top-Left'.
  - Audio Recording:** A checked checkbox.
  - Primary stream:**
    - Video Codec: H.264
    - Resolution: 1280\*720
    - Bit Rate Control: CBR
    - Bit Rate(Kbps): 2048
    - Image Quality: Normal
    - Frame Rate(fps): 30
    - I-frame Interval: 30
  - Secondary stream:**
    - Video Codec: H.264
    - Resolution: 320\*240
    - Bit Rate Control: CBR
    - Bit Rate(Kbps): 256
    - Image Quality: Normal
    - Frame Rate(fps): 15
    - I-frame Interval: 15
- Bottom:** A green 'Save' button.

**Figure 38: GVR3550 Encoding Config Page**

**Table 19: GVR3550 Encoding Config parameter Explanation:**

Parameter	Explanation
Camera Selection	Select a camera to configure codec configuration. It will display the camera's IP and model after selecting each camera.
Camera Name	Manual enter the camera's name.
Display Time	Select if display the IPC's time on Live View window.
Display Camera Name	Select if display the IPC's name on Live View window.

Position	Select position to Top-Left or Bottom-Left for displaying IPC's name and time on live view.
Audio Recording	Set audio recording.
<b>Primary Stream</b>	Primary stream is used for Play Black.
<b>Secondary Stream</b>	Secondary Stream is used for Live View.
Video Codec	Select the Codec for each IPC. Beta version just supports H.264.
Resolution	Configure the resolution for each IPC. The Primary Stream resolution can't support more than 1920*1080P. The Secondary Stream resolution can's support more than 640*480P (VGA).
Bit Rate Control	Set the Bit Rate Control to CBR or VBR.
Image Quality	Set the Image Quality, if the Bit Rate Control sets to VBR. It has 5 standards: Very High, High, Normal, Low, Very Low.
Bit Rate (kpbs)	Set the different Bit Rate for IPC. Bit Rate can change the image quality, the more bit rate the better image quality. The range for bit rate is from 256~8192Kbps.
Frame Rate (fps)	Set frame rate. The range is from 1~30fps.
i - frame interval	Set the video i-frame interval. The range is from 1~100s.



## SCHEDULE CONFIG

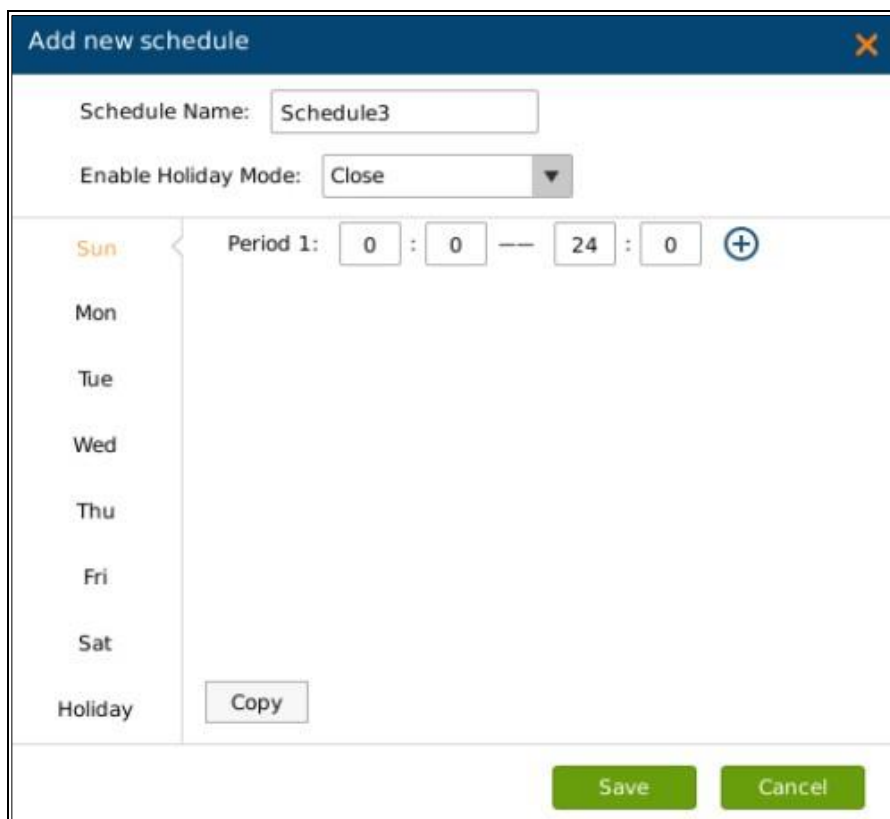

Add new schedule

Schedule Name:

Enable Holiday Mode:

Sun: Period 1:  :  --  :  (+)

Mon

Tue

Wed

Thu

Fri

Sat

Holiday

Figure 39: GVR3550 Add New Schedule Page

Schedule on the weekly basis: at least set one period and users could set up to 16 periods. See Figure 39.

**Modify Schedule** ✕

Schedule Name:

Enable Holiday Mode:

---

Sun

Mon

Tue

Wed

Thu

Fri

Sat

Holiday

Period 1:  :  ---  :  ⊖

Period 2:  :  ---  :  ⊕

Sun

Mon

Tue

Wed

Thu

Fri

Sat

Holiday

Cancel

Save

Cancel

*Figure 40: GVR3550 Schedule Config - Add New Schedule - Page*

Users could edit, modify, delete schedule in the schedule list.  
Click  to view the schedule details as shown in Figure 41.

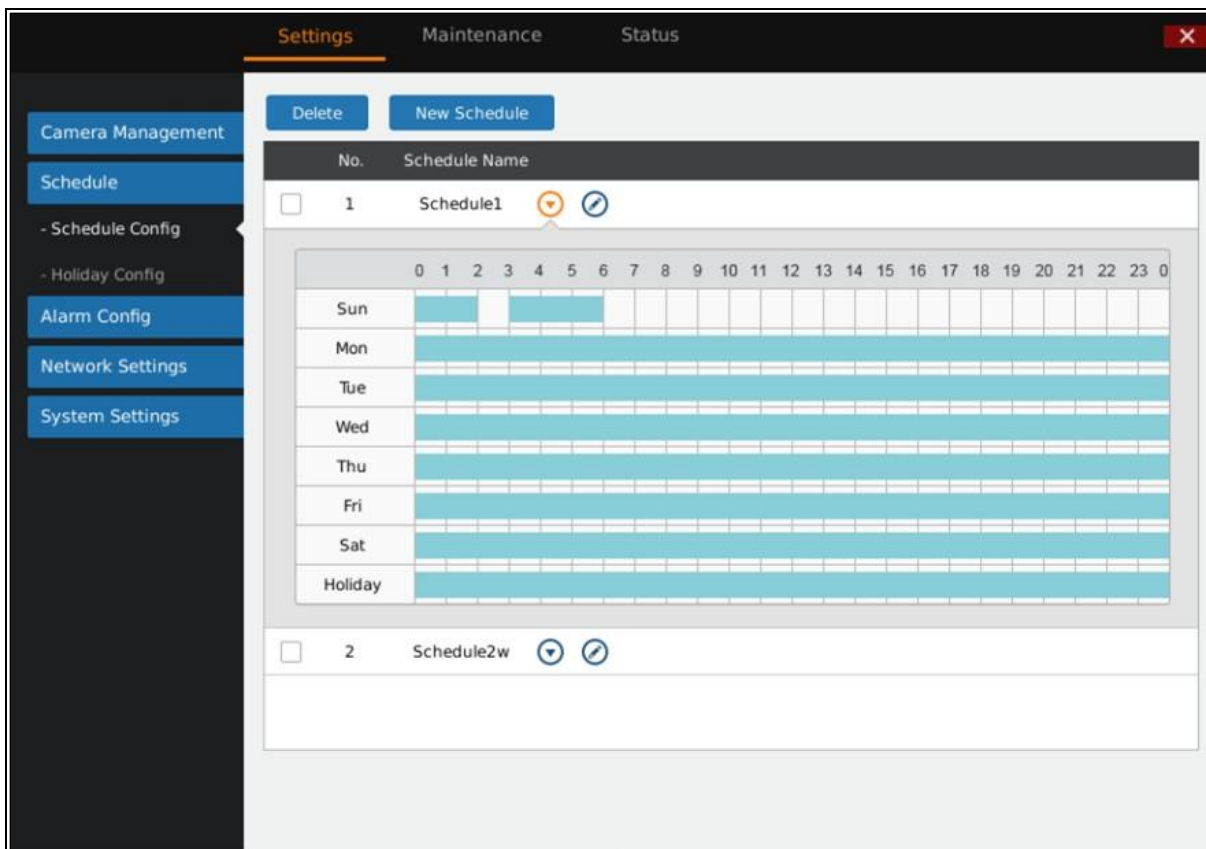

**Figure 41: GVR3550 Schedule Details Page**

Click  to bring up the schedule editing page

## HOLIDAY CONFIG

Users could add new holiday, manage schedule record, and alarm event of each camera. Users could add up to 16 holidays. See Figure 42 below.

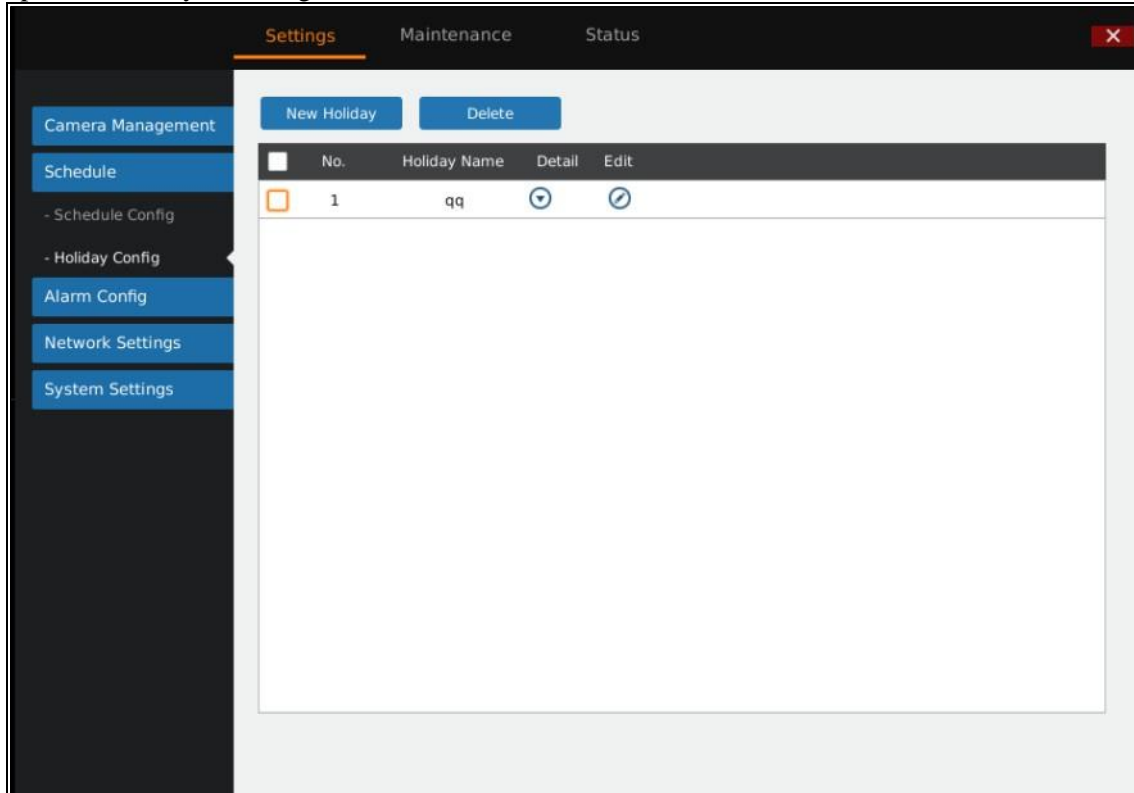
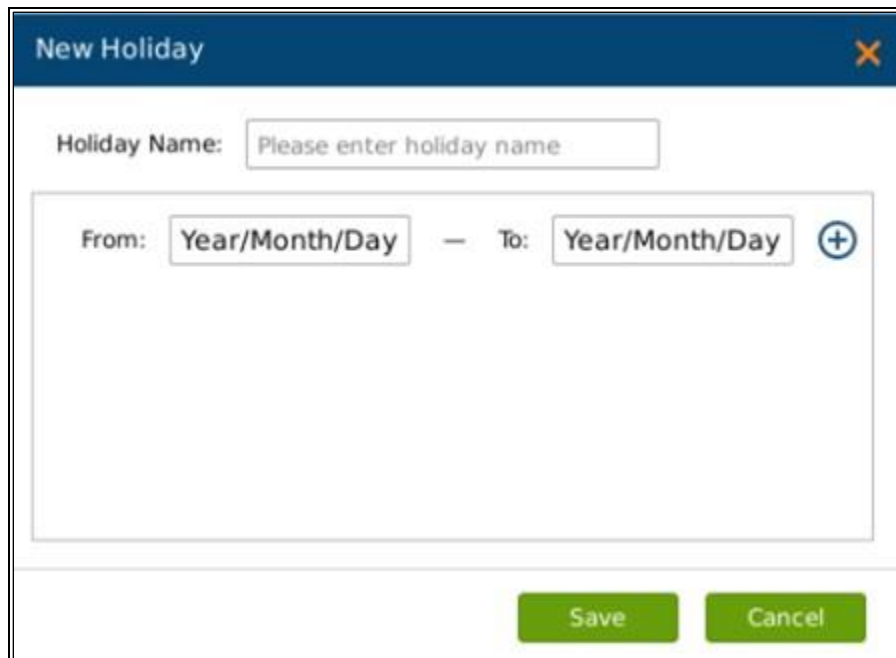

Figure 42: GVR3550 Holiday Config Page

Click "New Holiday" to bring up the page as shown in Figure 43 below. Users could custom holiday name.



**Figure 43: GVR3550 Add New Holiday Page**

Set holiday starting time and end time. Users could add up to 32 periods. See Figure 44 below:

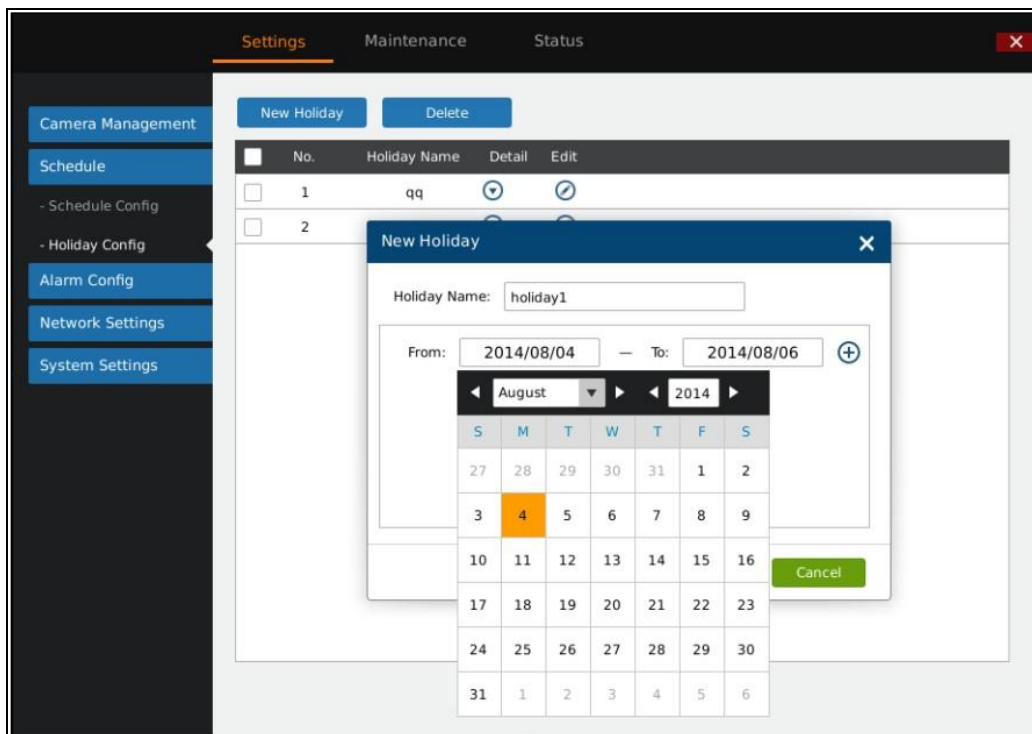

**Figure 44: GVR3550 Add New Holiday Editing Page**

Users could edit, modify, delete schedule in the holiday list.  
Click  to view the holiday details as shown in Figure 45.

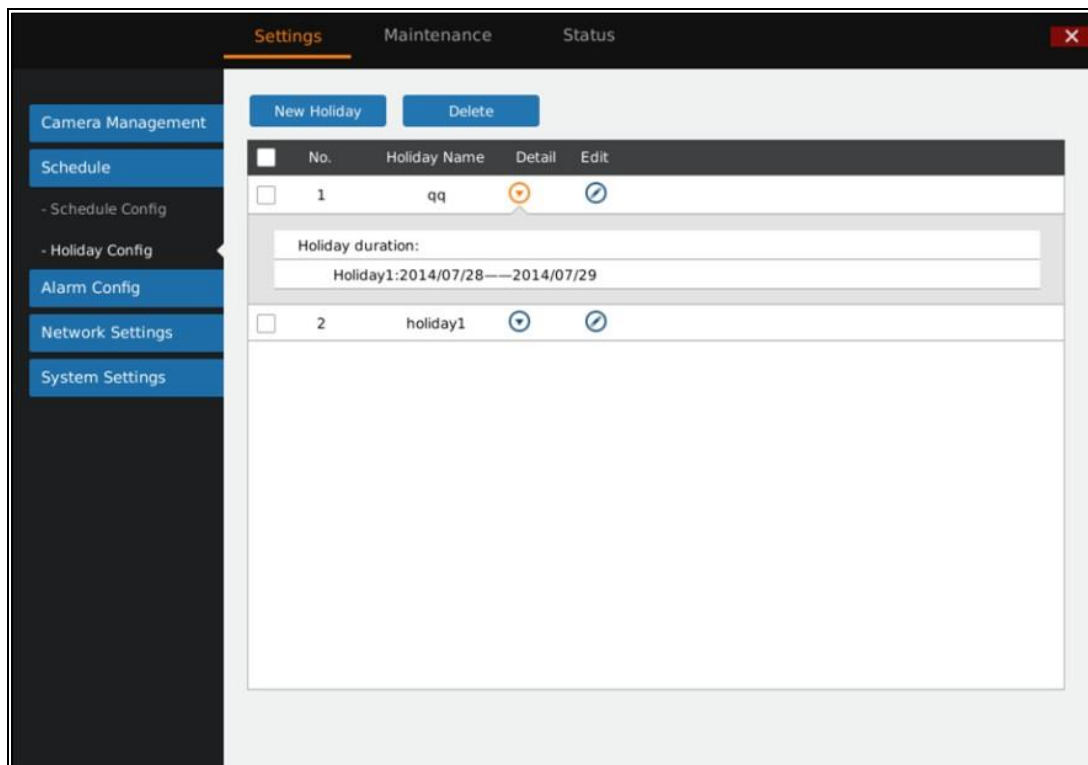

**Figure 45: GVR3550 Holiday Details Page**

Click  to bring up the holiday editing page

## ALARM CONFIG

The GVR3550 supports up to 16 channels alarm input and 2 channels alarm output. Please refer to the chapter *Connect Alarm Device* to connect the output and input devices.

### (IO) ALARM CONFIG

Users could set different alarm type to each corresponding camera, see Figure 46.

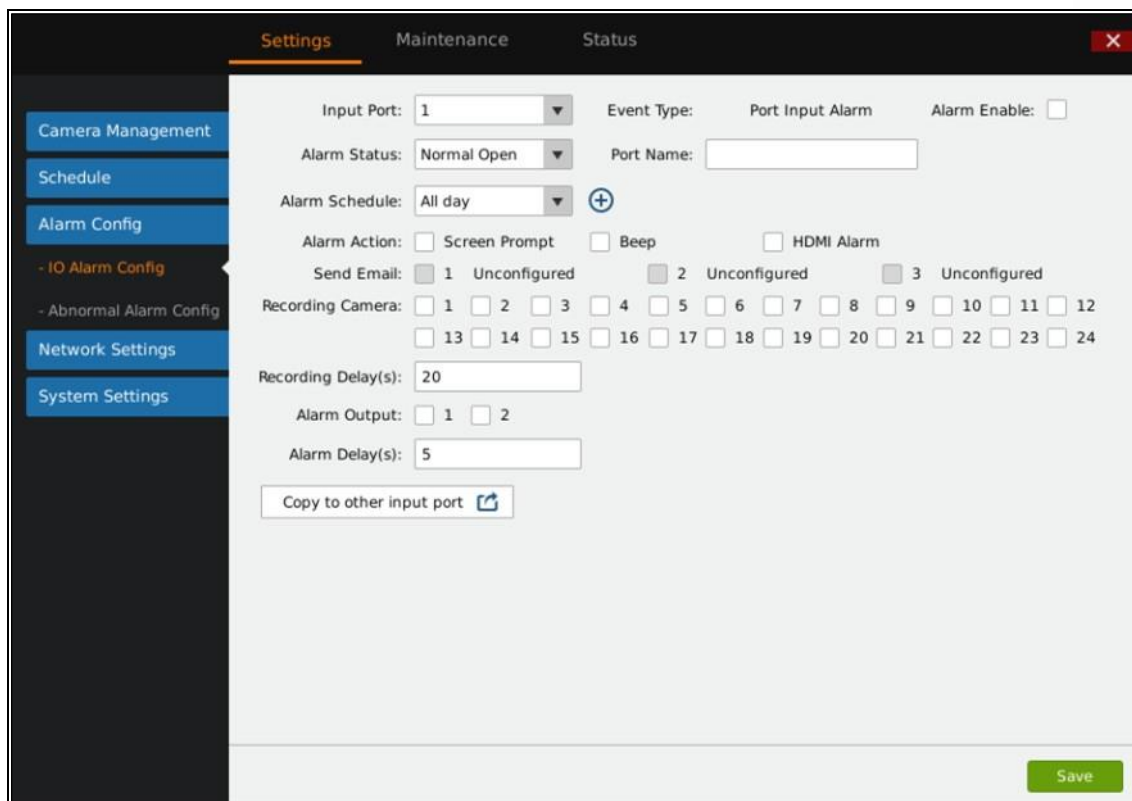

**Figure 46: GVR3550 I/O Alarm Config Page**

**Table 20: GVR3550 IO Alarm Config Parameter Explanation:**

Parameter	Explanation
<b>Input Port</b>	Select the input port No. Click to select the port No. of alarm input.
<b>Event Type</b>	Select the event type like Input Alarm.
<b>Alarm Enable</b>	Tick to enable/disable the alarm.
<b>Alarm Status</b>	Set the alarm status. Normally Open (default) and Normally Close are two available options. Please choose the status according to your alarm type. Restart to make changes take effect.
<b>Port Name</b>	Enter the port name of the alarm input to distinguish different input ports.
<b>Alarm Schedule</b>	Select alarm schedule in the drop-down list. If there is no existing schedule, users could click  to add new schedule and enter the setting page to configure. See Figure 47 below.

Add new schedule
✕

Schedule Name:

Enable Holiday Mode:

---

Sun

Mon

Tue

Wed

Thu

Fri

Sat

Holiday

Period 1:  :  --  :  +

**Figure 47: GVR3550 I/O Alarm Config – Add New Schedule - Page**

Users could set various alarm actions according to different alarm input such as Screen Prompt, Beeper, HDMI Alarm, Send Email, or Copy Alarm to Other Camera. The Parameters settings are the same in chapter **Camera Event Settings**.



## ABNORMAL ALARM CONFIG

Abnormal Alarm Config includes Disconnection Alarm, HDD Empty Alarm, HDD Full Alarm, HDD Error Alarm and IP Conflict Alarm. See Figure 48 below. Users can set the alarm actions after selecting the corresponding alarms.

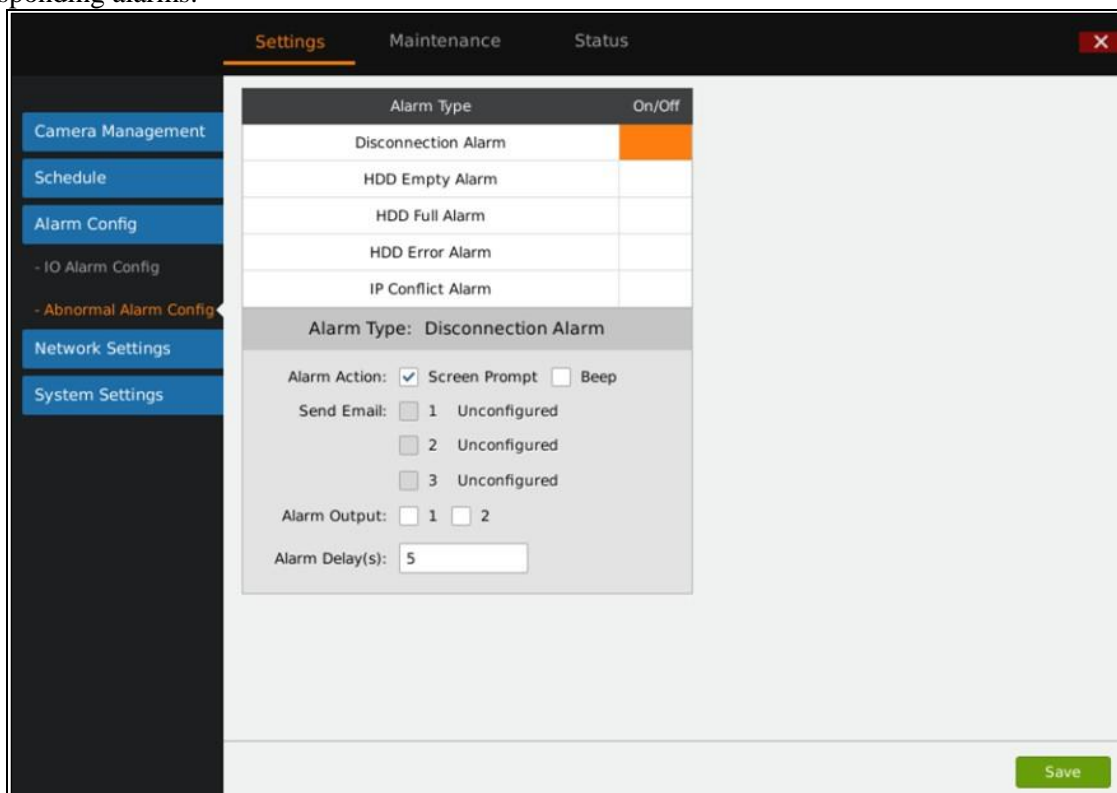

Figure 48: GVR3550 Abnormal Alarm Config Page

Table 21: GVR3550 Abnormal Alarm Parameter Explanation:

Parameter	Explanation
<b>Disconnection Alarm</b>	Alarm when detecting no cable access
<b>HDD Empty Alarm</b>	Alarm when detectng without HDD access
<b>HDD Full Alarm</b>	Alarm when HDD is fuill
<b>HDD Error Alarm</b>	Alarm when detecting HDD error
<b>IP Conflict Alarm</b>	Alarm when the IP address is conflict with the GVR address

Users could set various alarm actions like Screen Prompt, Beeper, HDMI Alarm, Send Email, or Copy Alarm to Other Camera. The Parameters settings are the same in chapter *Camera Event Settings*.

## NETWORK SETTINGS

Network Settings includes Basic Settings and Advanced Settings. Users could easily realize network connection and ensure network security.

### BASIC SETTINGS

Basic Settings page is shown in Figure 49 below, users can choose to obtain IPv4 address automatically or manual set static IP address or use PPPoE. The GVR3550 is available only when network setup is correct.

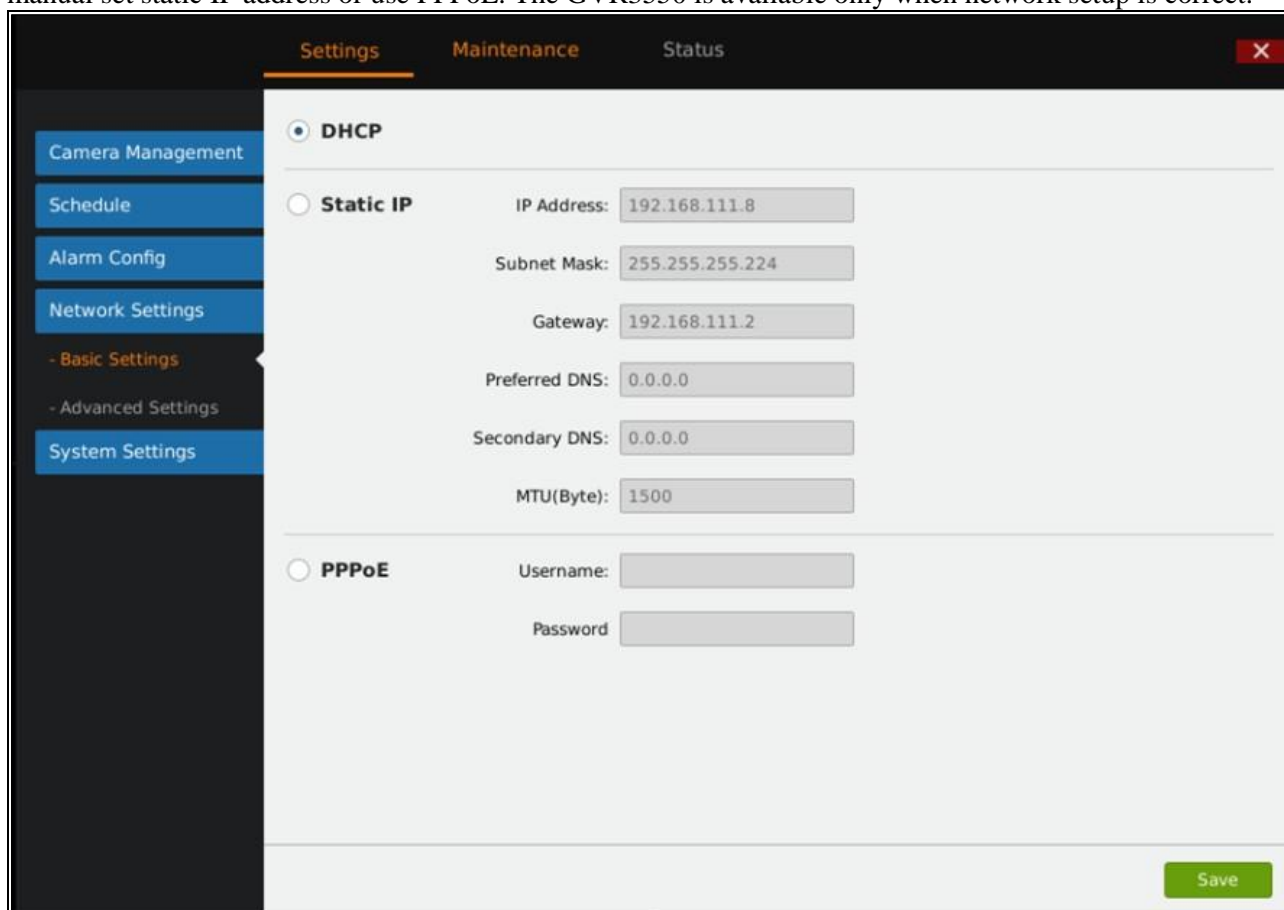

Figure 49: GVR3550 Network Settings – Basic Setting Page

**Table 22: GVR3550 Basic Network Parameter Explanation:**

Parameter	Explanation
<b>DHCP</b>	Obtain IPV4 address from the DHCP server automatically
<b>Static IP</b>	Set static network parameters
IP Address	Manual enter the IPV4 address
Subnet Mask	Manual enter the IPV4 subnet mask
Gateway	Manual enter the IPV4 default gateway address
Preferred DNS	Manual enter the preferred DNS server address
Secondary DNS	Manual enter the secondary DNS server address
MTU (Byte)	Enter MTU (Maximum Transmission Unit), the maximum data package that can be transmitted on the network. If the GVR MTU is larger than the one of the gateway, the lager one will be split for transmission. Please confirm the MTU value of your gateway before set
<b>PPPoE</b>	Tick to set static network parameters
Username	Manual enter the username provided by the network vendor
Password	Manual enter the password provided by the network vendor

## ADVANCED SETTINGS

Advanced Settings page is shown in Figure 50. Users can set DDNS, UPnP and DHCP.

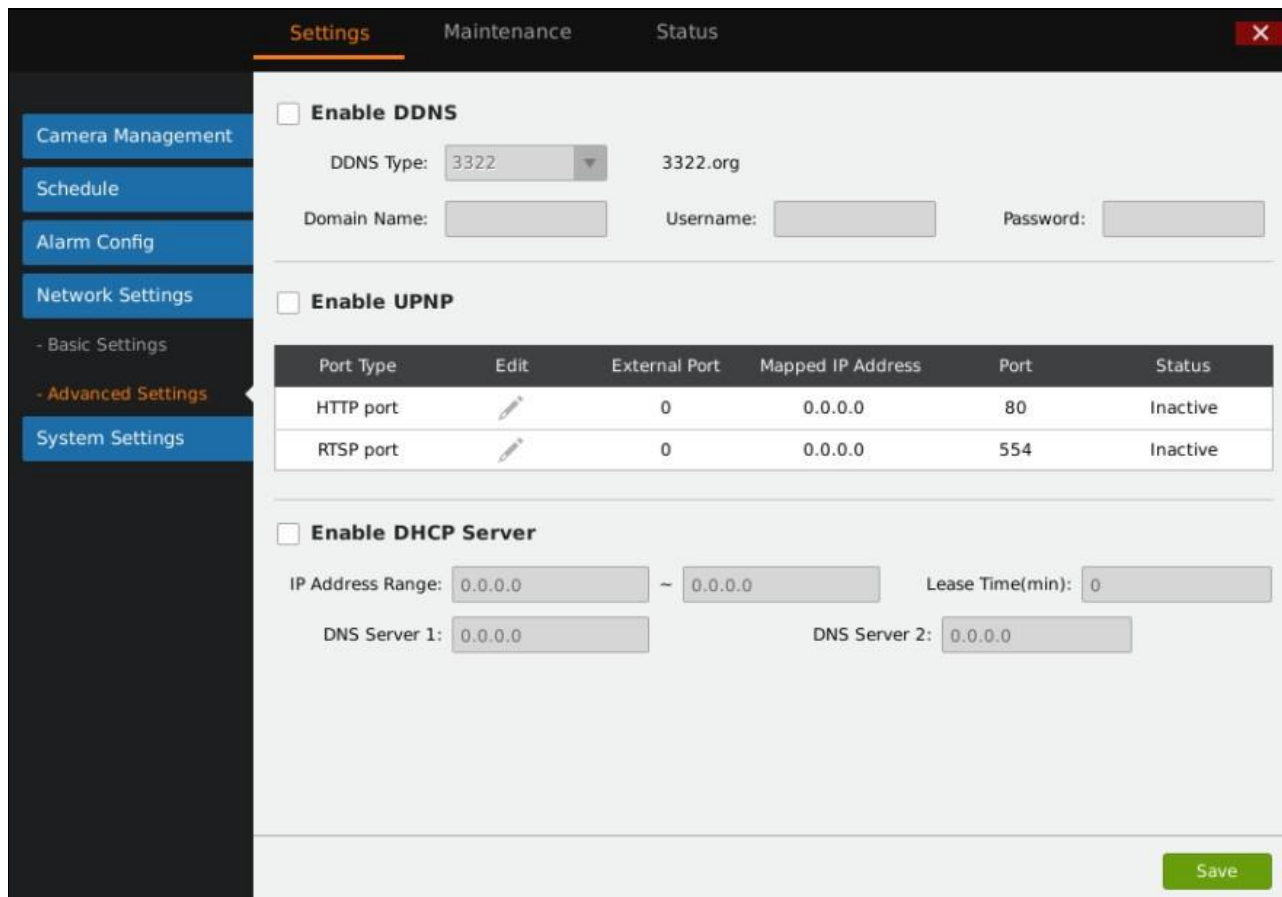



**Settings** Maintenance Status

**Enable DDNS**

DDNS Type: 3322 3322.org

Domain Name: Username: Password:

**Enable UPnP**

Port Type	Edit	External Port	Mapped IP Address	Port	Status
HTTP port		0	0.0.0.0	80	Inactive
RTSP port		0	0.0.0.0	554	Inactive

**Enable DHCP Server**

IP Address Range: 0.0.0.0 ~ 0.0.0.0 Lease Time(min): 0

DNS Server 1: 0.0.0.0 DNS Server 2: 0.0.0.0

Save

Figure 50: GVR3550 Network Settings – Advanced Settings Page

### ENABLE DDNS

Enable DDNS to access the GVR via the domain name if already enabled PPPoE connection to the internet, with this way can effectively solve the problem brought by access GVR with dynamic IP.

Select the proper DDNS type in the drop-down list and input the correct domain name, username and password to complete the DDNS settings.

### ENABLE UPnP

The full name of UPnP is Universal plug-in and Play, enable NAT of UPnP can realize auto port mapping thus allows external computer to access intranet to enhance network efficiency.

After ticking "Enable UPnP", users can click  to set the external port No., as shown in Figure 51 below.

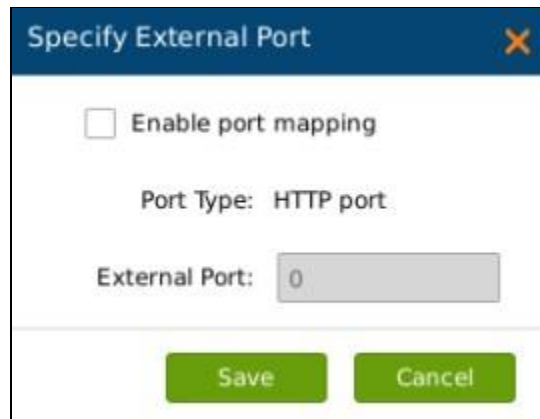

The image shows a dialog box titled "Specify External Port" with a close button (X) in the top right corner. Inside the dialog, there is a checkbox labeled "Enable port mapping" which is currently unchecked. Below this, the text "Port Type: HTTP port" is displayed. Underneath, there is a text input field labeled "External Port:" containing the number "0". At the bottom of the dialog, there are two green buttons: "Save" and "Cancel".

**Figure 51: GVR3550 Specify UPnP External Port Page**

When the port status displays "Active", it indicates the successful connection of the GVR and the router and the parameters have taken effect.

### ***ENABLE DHCP***

GVR3550 could allocate dynamic IP address to other devices within the same LAN. Follow the procedures below to set:

1. Tick "Enable DHCP Server";
2. Input the assignable IP address.
3. Input Lease Time;
4. Set DNS server address and the secondary DNS server address.

# SYSTEM SETTINGS

System Settings includes 8 options like Basic Settings, Display Settings, Local View Control, HDD Management, etc.

## BASIC SETTINGS

Basic Settings page is shown in Figure 52 below, users could set Recording File Size, Live View Performance, language, Time Zone, etc.

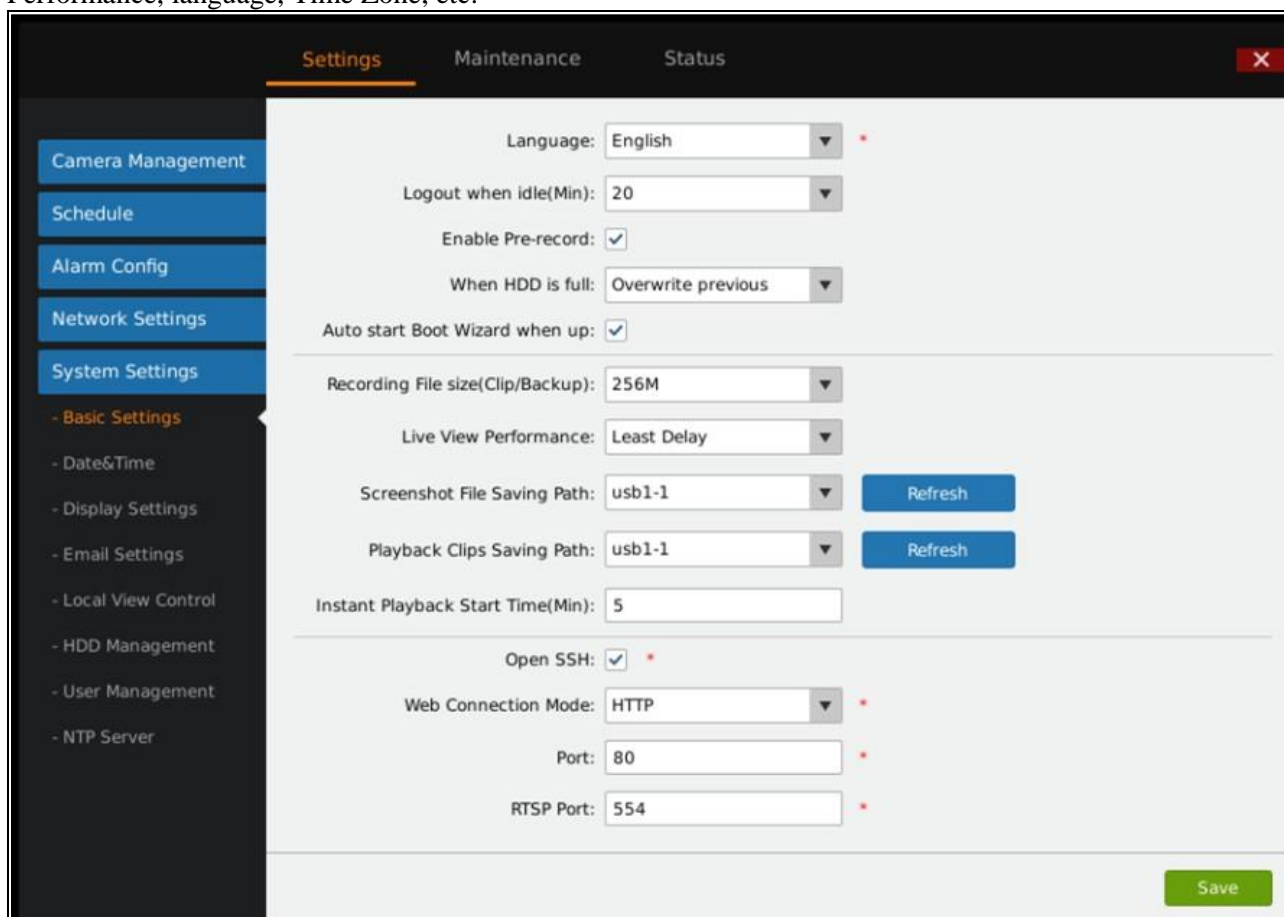

The screenshot displays the 'Basic Settings' page within the 'System Settings' section. The sidebar on the left lists various settings categories, with 'Basic Settings' currently selected. The main content area contains the following configuration options:

- Language: English (dropdown menu)
- Logout when idle(Min): 20 (dropdown menu)
- Enable Pre-record:
- When HDD is full: Overwrite previous (dropdown menu)
- Auto start Boot Wizard when up:
- Recording File size(Clip/Backup): 256M (dropdown menu)
- Live View Performance: Least Delay (dropdown menu)
- Screenshot File Saving Path: usb1-1 (dropdown menu) with a Refresh button
- Playback Clips Saving Path: usb1-1 (dropdown menu) with a Refresh button
- Instant Playback Start Time(Min): 5 (text input field)
- Open SSH:
- Web Connection Mode: HTTP (dropdown menu)
- Port: 80 (text input field)
- RTSP Port: 554 (text input field)

A green 'Save' button is located at the bottom right of the settings area.

Figure 52: GVR3550 System Settings Page – Basic Settings Page

**Table 23: GVR3550 Basic System Setting Parameter Explanation:**

Parameter	Explanation
<b>Language</b>	Set the language to English or Chinese
<b>Logout when idle(Min)</b>	Set the logout time when timeout. If logout, users need to login again to make operations except preview.
<b>Enable Pre-record(s)</b>	Set pre-record mode. Once enabled, users could view the record images a few seconds before alarm in alarm event
<b>When HDD Full</b>	Set the record policy when HDD is full. "Overwrite Previous" means the new record will overwrite the earliest ones when HDD is full of records. The default setting is "Stop Record"
<b>Auto start Boot Wizard when up</b>	Set whether to enable wizard when boot up. Once ticked, the wizard will pop up for installation
<b>Recording File size(Clip/Backup)</b>	The file size of recording (Clips/Backups).Users could choose 256M or 512M. Default is 256M.
<b>Live View Performance</b>	Set the view performance to Least Delay, Best Fluency and Balanced. Least delay emphasizes the fluency of the record while best fluency emphasizes the real-time of the recording. The default setting is "Least Delay"
<b>Screenshot File Saving Path</b>	Set the default path to save the screenshot file when preview and playback
<b>Playback Clips Saving Path</b>	Set the default path to save the clipping file when playback
<b>Instant Playback Start Time(Min)</b>	Set the start time for instant playback. The default is 5 minutes
<b>Open SSH</b>	Set whether to open SSH
<b>Web Connection Mode</b>	Set the web connection mode to HTTP or HTTPS, the default is HTTP
<b>Port</b>	Set the port No. of web connection, the default is 80.
<b>RTSP Port</b>	Set the port number of RTSP, the default is 554.

## DATE&TIME

Users could set system time. See Figure 53 below.

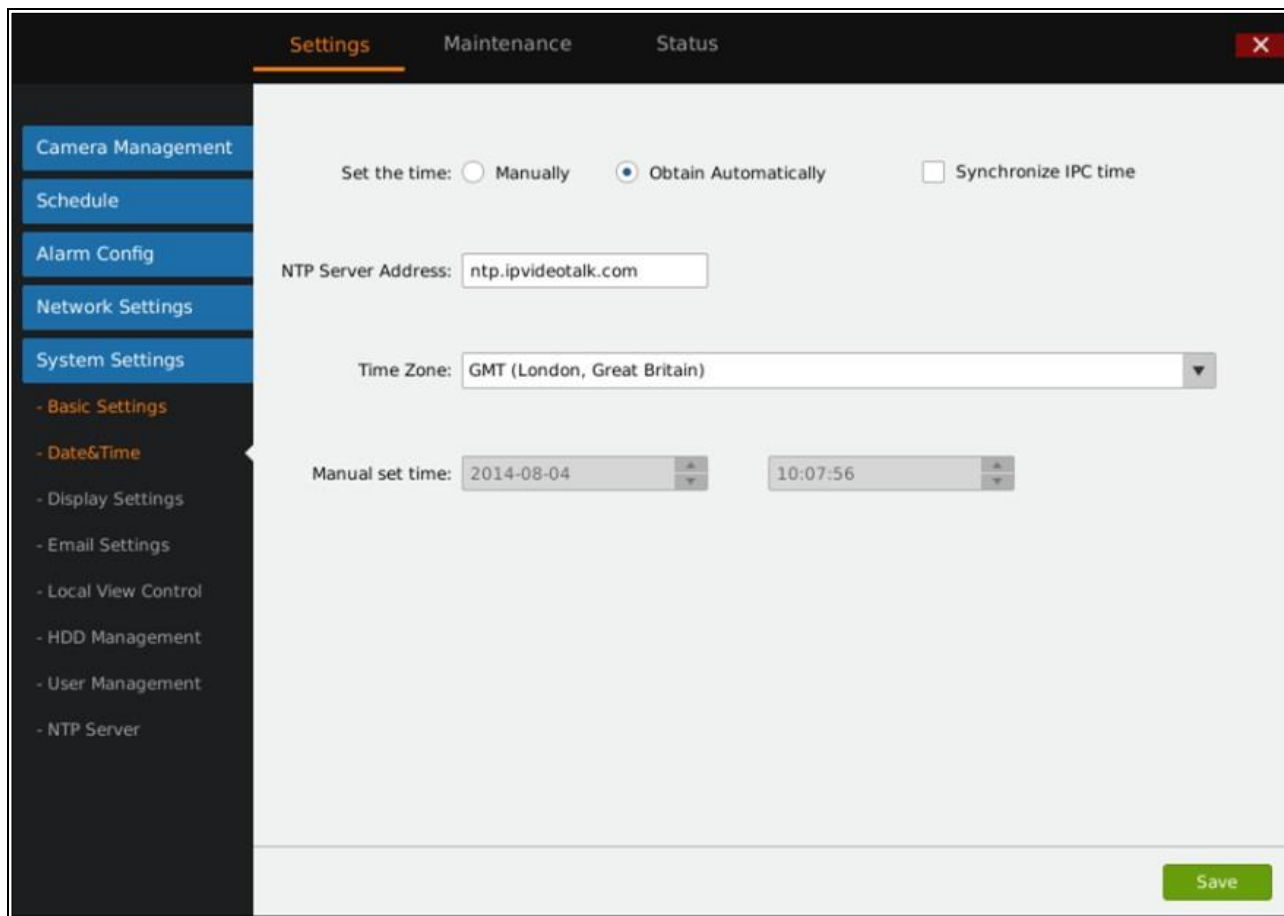

The screenshot shows the 'Settings' tab of the GVR3550 system. The left sidebar lists various settings categories, with 'System Settings' expanded to show 'Date&Time' selected. The main content area is titled 'Settings' and contains the following configuration options:

- Set the time:** Three radio buttons are present: 'Manually' (unselected), 'Obtain Automatically' (selected), and 'Synchronize IPC time' (unselected).
- NTP Server Address:** A text input field containing 'ntp.ipvideotalk.com'.
- Time Zone:** A dropdown menu currently set to 'GMT (London, Great Britain)'.
- Manual set time:** Two time pickers. The first shows the date '2014-08-04' and the second shows the time '10:07:56'.

A green 'Save' button is located at the bottom right of the settings area.

**Figure 53: GVR3550 System Settings Page – Date & Time**

**Table 24: GVR3550 Basic System Setting – Date & Time Parameter Explanation:**

Parameter	Explanation
<b>Set the time</b>	Users could manual set the time, obtain time from the NTP server automatically
Manually	Manual set time
Obtain Automatically	Obtain time automatically from configured NTP server
Synchronize IPC time	Synchronize the GVR time to the connected IP cameras
<b>NTP Server Address</b>	Users could manual set the time or obtain time from the NTP server automatically
<b>Time Zone</b>	Manual set the time zone.
<b>Manual set time</b>	Manual set the system time.



## DISPLAY SETTINGS

Users could set output mode and adjust output value like Brightness, Contrast, Saturation, Hue of the connected display device. See picture 54 below.

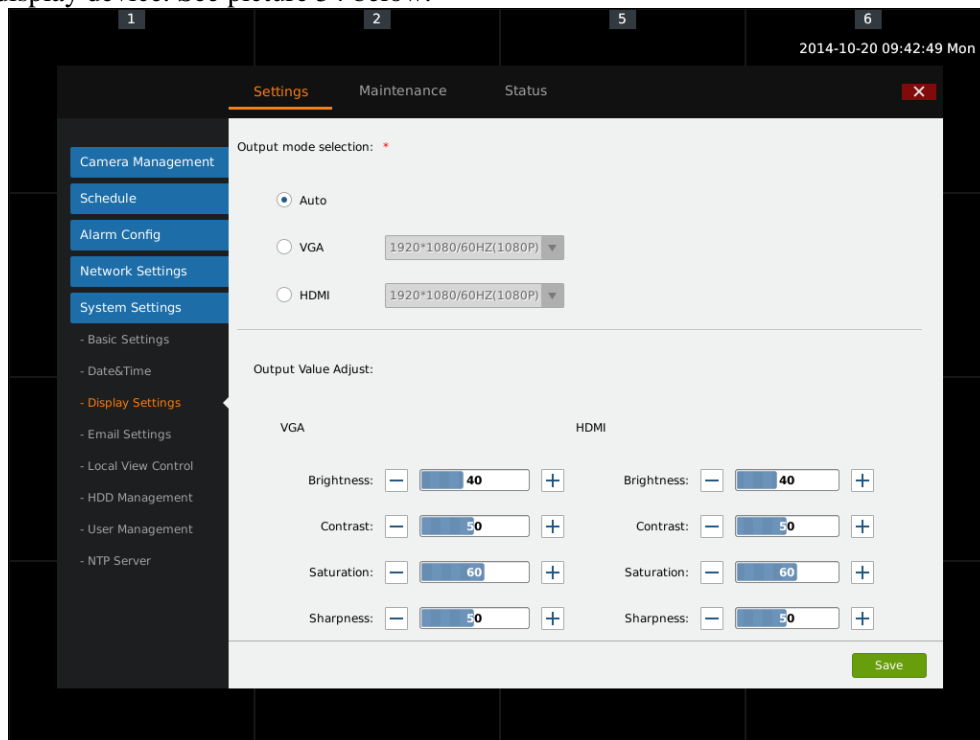

Figure 54: GVR3550 System Settings Page – Display Settings

Table 25: GVR3550 Basic System Setting – Display Parameter Explanation:

Parameter	Explanation
Output mode selection	Users could select output mode: Auto, VGA, HDMI. VGA not support automatic resolution matching. Both VGA/HDMI connected only HDMI is in effective (default HDMI). Dual Output mode need configured to display VGA and HDMI simultaneously. Maximum resolution of 1080p for HDMI or VGA could be configured
Brightness	Set the GVR brightness. The reference range is 0~100
Contrast	Set the GVR contrast. The reference range is 0~100
Saturation	Set the GVR saturation. The reference range is 0~100
Hue	Set the GVR saturation. The reference range is 0~100

## EMAIL SETTINGS

The GVR3550 could send Email when triggered alarm, the procedures are as follows:

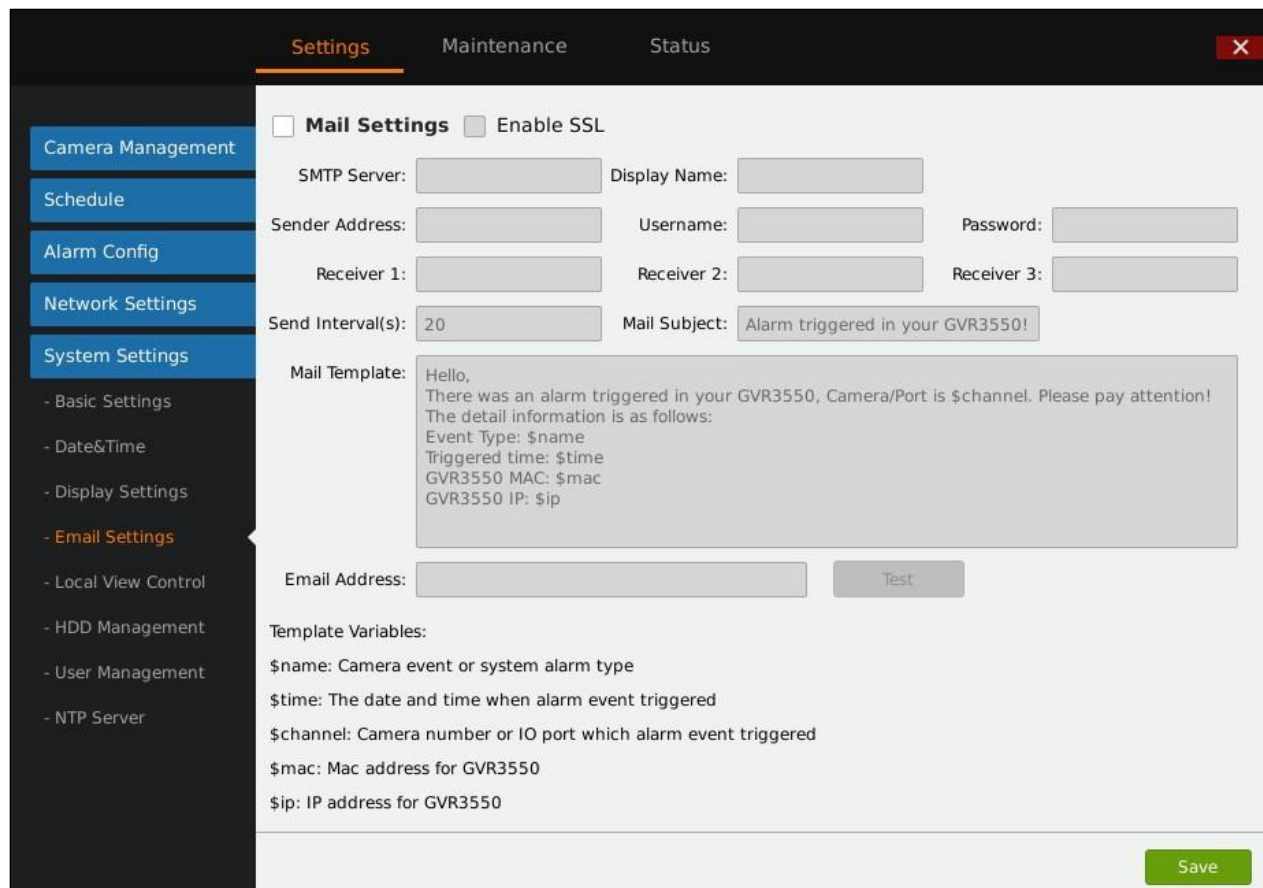

The screenshot shows the 'Email Settings' configuration page in the GVR3550 web interface. The page is titled 'Settings' and includes a sidebar with navigation options like 'Camera Management', 'Schedule', 'Alarm Config', 'Network Settings', and 'System Settings'. The 'Email Settings' section is active, showing fields for SMTP Server, Display Name, Sender Address, Username, Password, Receiver 1, 2, and 3, Send Interval(s) (set to 20), and Mail Subject (set to 'Alarm triggered in your GVR3550!'). A 'Mail Template' field contains a default message with variables like \$name, \$time, \$channel, \$mac, and \$ip. A 'Test' button is available next to the 'Email Address' field. A 'Save' button is located at the bottom right of the form.

**Figure 55: GVR3550 System Settings Page – Email Settings**

1. Set SMTP server address;
2. Input the display name, sender address, username and password;
3. Set receiver address. The GVR3550 could set up to 3 receiver addresses. Users could send mails to different receivers;
4. Set mail send interval. One alarm only sends one email in the interval;
5. Set mail subject and template. Users could use default ones or custom them.

**Table 26: GVR3550 Email Template Parameter Explanation:**



#	Key Word	Explanation
1	\$name	Name of Alarm
2	\$time	Time of Alarm Triggered
3	\$channel	Channel number of Alarmed IP Camera
4	\$mac	MAC address of GVR3550
5	\$ip	IP address of GVR3550

## LOCAL VIEW CONTROL

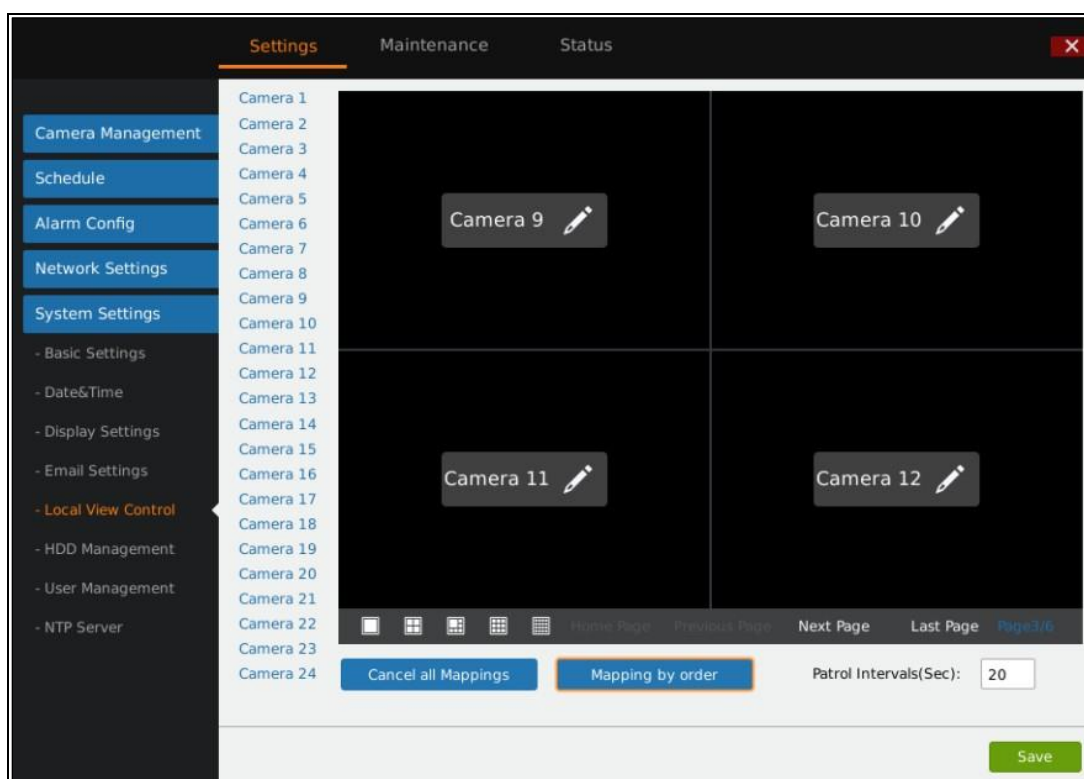
Local View Control is to set camera and the patrol interval, as shown in Figure 56 below.



**Figure 56: GVR3550 System Settings Page – Local View Control**

The connected camera name will be displayed on the left list. Click on  to access the camera page and tick  before the camera name to map the corresponding camera.

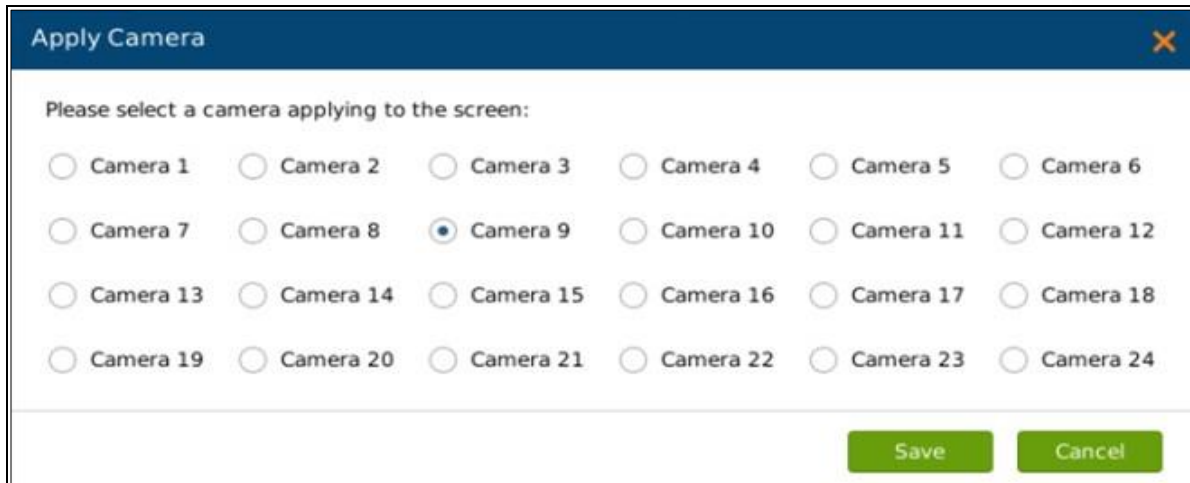

**Figure 57: GVR3550 Local View Control – Apply Camera**

## HDD MANAGEMENT

HDD Management page is shown in Figure 58 below. Users could view each HDD storage status or format HDD, erase data, configure attribution, etc.

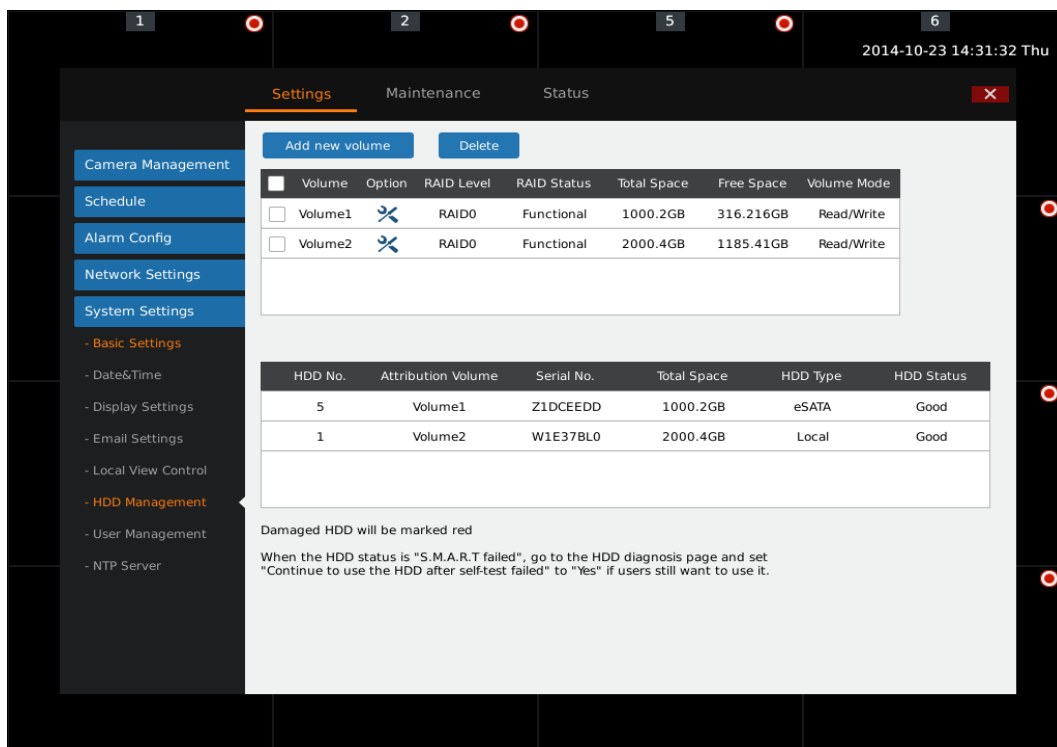

**Figure 58: GVR3550 System Settings Page – HDD Management**

- **Add New Volume:** Access the detail page to set volume
- **Delete:** Delete existing volume. Users could delete the existing volume, please consider carefully before apply. Once deleted, the volume data will be all erased and could not be restored.

Add New Volume page is shown below.

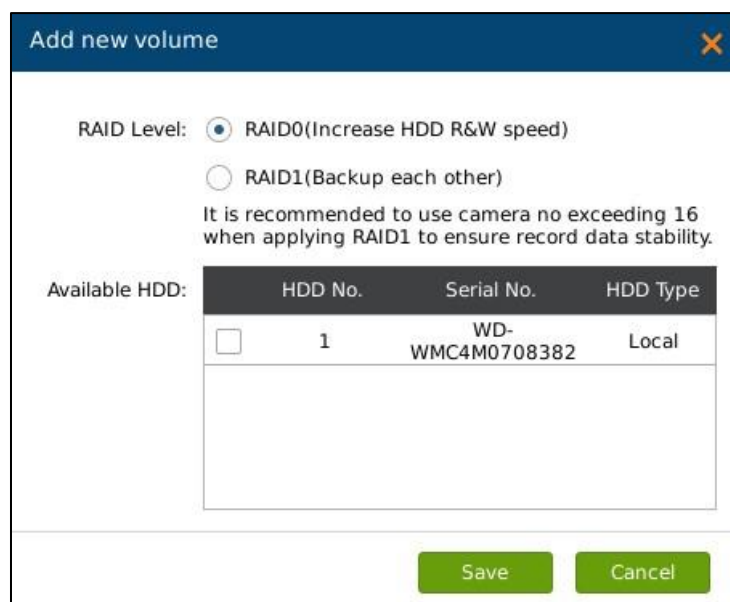

**Add new volume**

RAID Level:  RAID0(Increase HDD R&W speed)  
 RAID1(Backup each other)

It is recommended to use camera no exceeding 16 when applying RAID1 to ensure record data stability.

Available HDD:

	HDD No.	Serial No.	HDD Type
<input type="checkbox"/>	1	WD-WMC4M0708382	Local

Save Cancel

**Figure 59: GVR3550 HDD Management – Add New Volume**

Edit Volume Property page is shown below.



**Edit Volume Property**

Format Volume:

Erase All Data:

Configure Property:  ▼

Save Cancel

**Figure 60: GVR3550 HDD Management – Edit Volume Property**

**Table 27: GVR3550 Edit Volume Property Parameter Explanation:**

Parameter	Explanation
<b>Format Volume</b>	Users could format the existing volume, please consider carefully before apply. Once formatted, the volume data will be all erased and could not be restored.
<b>Erase All Data</b>	Users could erase all data of the existing volume, please consider carefully before apply. Once formatted, the volume data will be all erased and could not be restored other than the locked record
<b>Configure Property</b>	Users could set the property of existing volume to Read-Write or Read-only. The volume will not save record if set to Read-only.

**Table 28: GVR3550 HDD RAID Parameter Explanation:**

Parameter	Explanation
<b>New Disk Array</b>	Configure RAID
<b>Delete</b>	Delete configured RAID. Caution: All data will be erased and not be able to recover once RAID deleted.
<b>RAID Class</b>	Select the RAID Class need to be configured

**Table 29: GVR3550 HDD Management Parameter Explanation:**

Parameter	Explanation
<b>Format RAID</b>	Format RAID configured. Caution: Data will be erased and cannot be recovered once command issued.
<b>Erase All Data</b>	Erase all data in RAID. Caution: All data will be erased excepted locked recording.
<b>Property Config</b>	Configure the Read/Write Property of RAID. Once configure Read Only, the RAID will not be able to record new data.

## USER MANAGEMENT

The GVR3550 could add up to 30 users .

Users can be operator or normal user as shown in Figure 61 below.

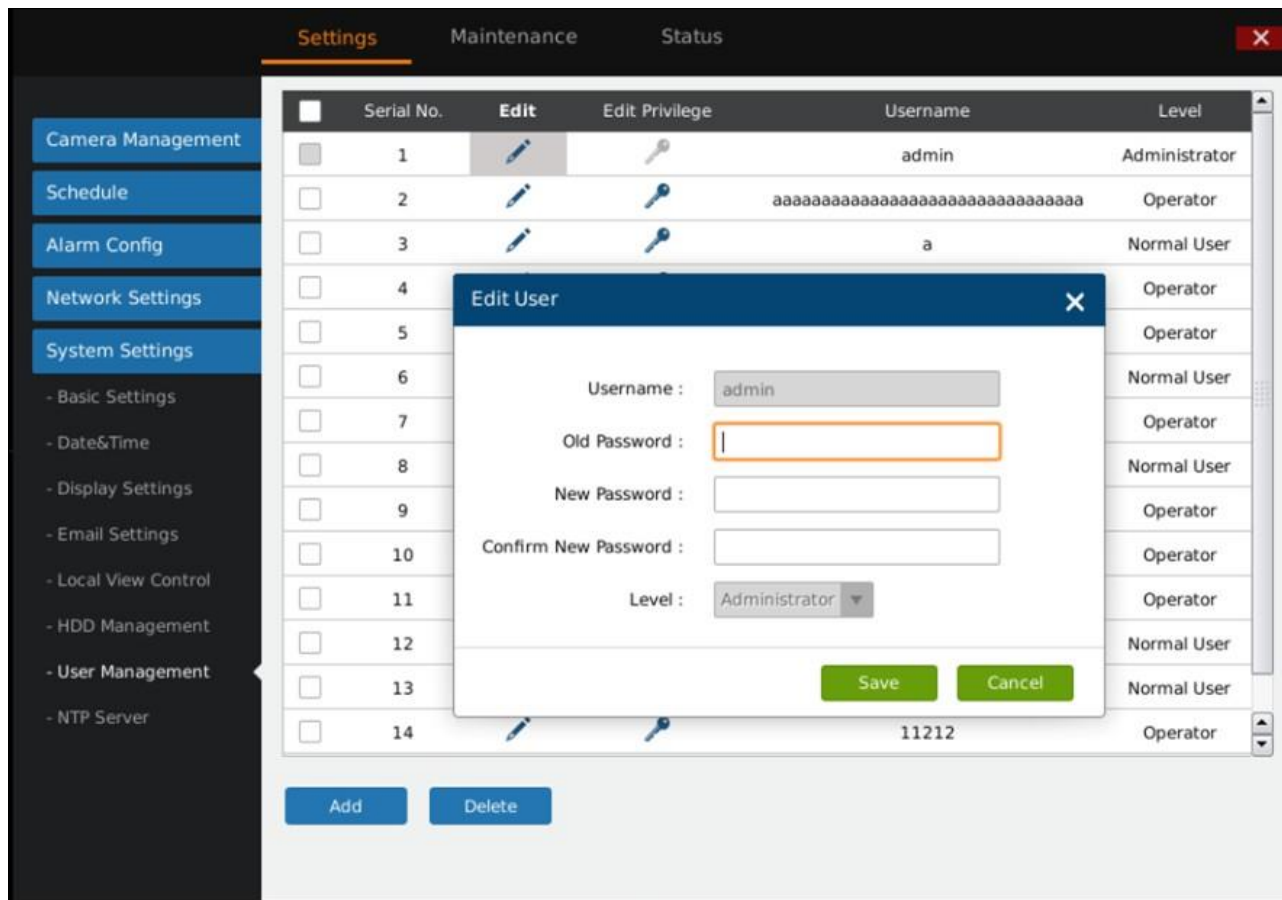

Serial No.	Edit	Edit Privilege	Username	Level
1			admin	Administrator
2			aaaaaaaaaaaaaaaaaaaaaaaaaaaaaaaa	Operator
3			a	Normal User
4				Operator
5				Operator
6				Normal User
7				Operator
8				Normal User
9				Operator
10				Operator
11				Operator
12				Normal User
13				Normal User
14			11212	Operator

Figure 61: GVR3550 System Setting Page – User Management

### **NOTE:**

- Only administrator user has the authority to access user management.

## ADDING A USER

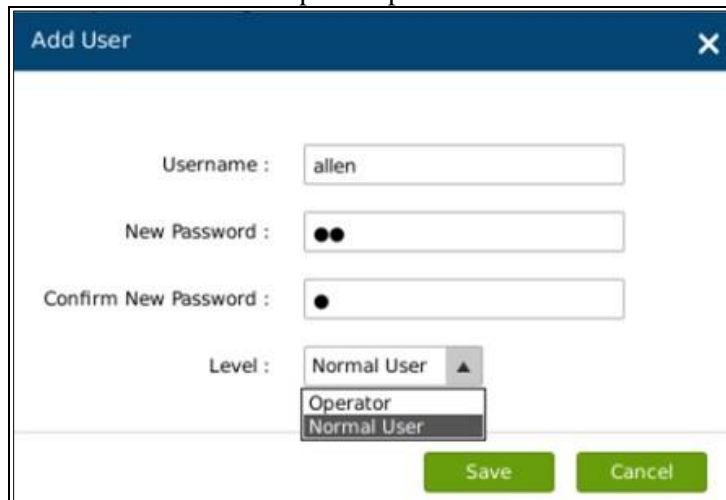

Click "Add" to bring up the page as shown in Figure 62 below. Users could input username, password and select level: operator and normal user are two optional permissions available.

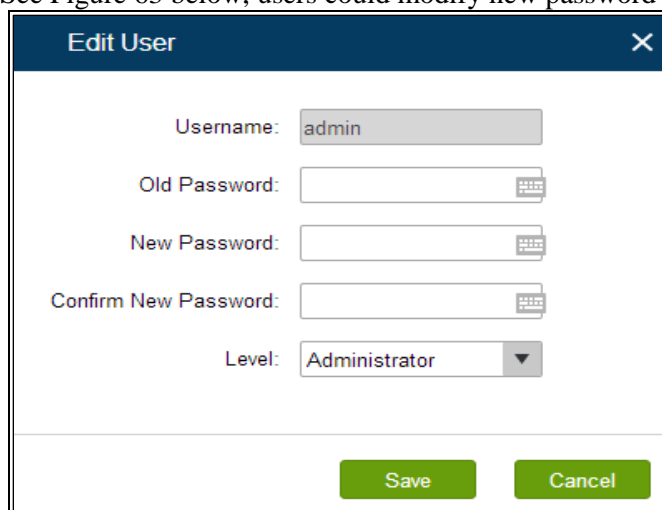

**Figure 62: GVR3550 User Management – Add User**

Click on the "Save" button to save.

## INPUT USER INFO AND EDITING PRIVILEGE

The new created user privilege is default, users could modify the user information and privilege via clicking on  and . See Figure 63 below, users could modify new password and user level.



**Figure 63: GVR3550 User Management – Edit User**



The normal user only has camera privilege like playback and remote preview. Tick to set. See figure 64.

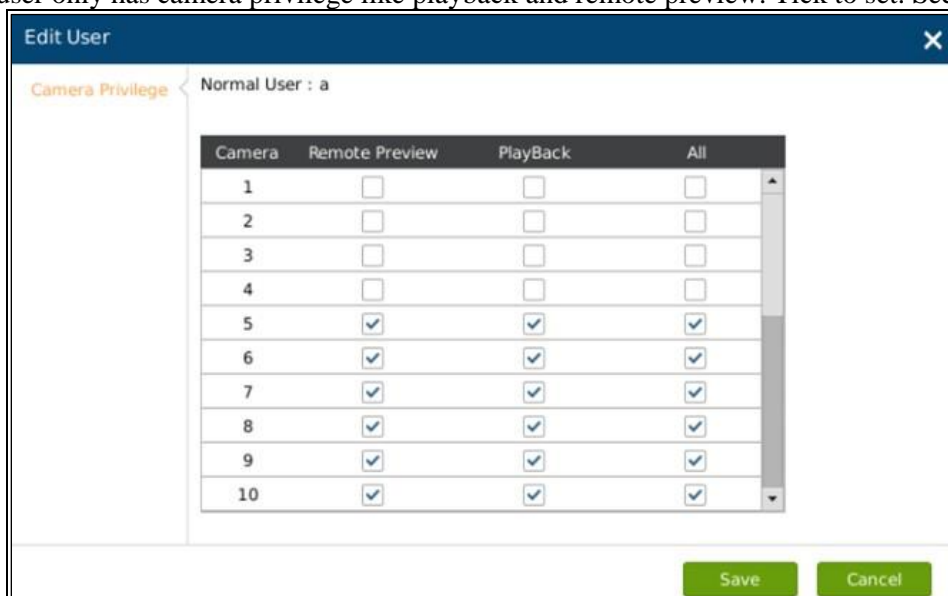

Camera	Remote Preview	PlayBack	All
1	<input type="checkbox"/>	<input type="checkbox"/>	<input type="checkbox"/>
2	<input type="checkbox"/>	<input type="checkbox"/>	<input type="checkbox"/>
3	<input type="checkbox"/>	<input type="checkbox"/>	<input type="checkbox"/>
4	<input type="checkbox"/>	<input type="checkbox"/>	<input type="checkbox"/>
5	<input checked="" type="checkbox"/>	<input checked="" type="checkbox"/>	<input checked="" type="checkbox"/>
6	<input checked="" type="checkbox"/>	<input checked="" type="checkbox"/>	<input checked="" type="checkbox"/>
7	<input checked="" type="checkbox"/>	<input checked="" type="checkbox"/>	<input checked="" type="checkbox"/>
8	<input checked="" type="checkbox"/>	<input checked="" type="checkbox"/>	<input checked="" type="checkbox"/>
9	<input checked="" type="checkbox"/>	<input checked="" type="checkbox"/>	<input checked="" type="checkbox"/>
10	<input checked="" type="checkbox"/>	<input checked="" type="checkbox"/>	<input checked="" type="checkbox"/>

Figure 64: GVR3550 User Management – Edit Normal User

Besides camera privilege, the operator user also has configured privilege. Tick to set. See Figure 65.

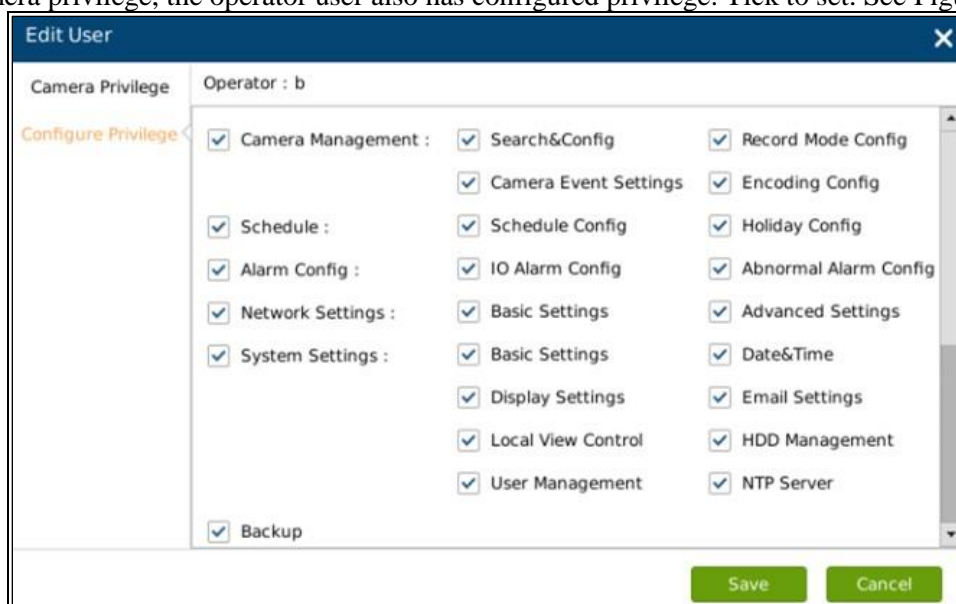

Figure 65: GVR3550 User Management – Edit Operator User



**NOTE:**

➤ All users have the permission to access local view by default. Local view has no access restrictions.

## **DELETING A USER**

All user accounts can be deleted except the administrator account. Tick the user you want to delete then click on the "Delete" button below the page to delete.

Privilege Specifications:

**Administrator.**All privilege by default.

**Operator.**Camera Privilege and part of Configure Privilege except User Management, Upgrade, Reset and Import &Export.

**Normal User.**Part of Camera Privilege except Manual Operation.

**Camera Privilege.**Remote Preview, Manual Operation, Playback.

**Configure Privilege.**Camera Management, Schedule, Alarm Config, Alarm Settings, Network Settings, System Settings, etc.

## NTP SERVER

GVR could provide other devices with NTP service. Tick "Enable NTP Server". See Figure 66 below.

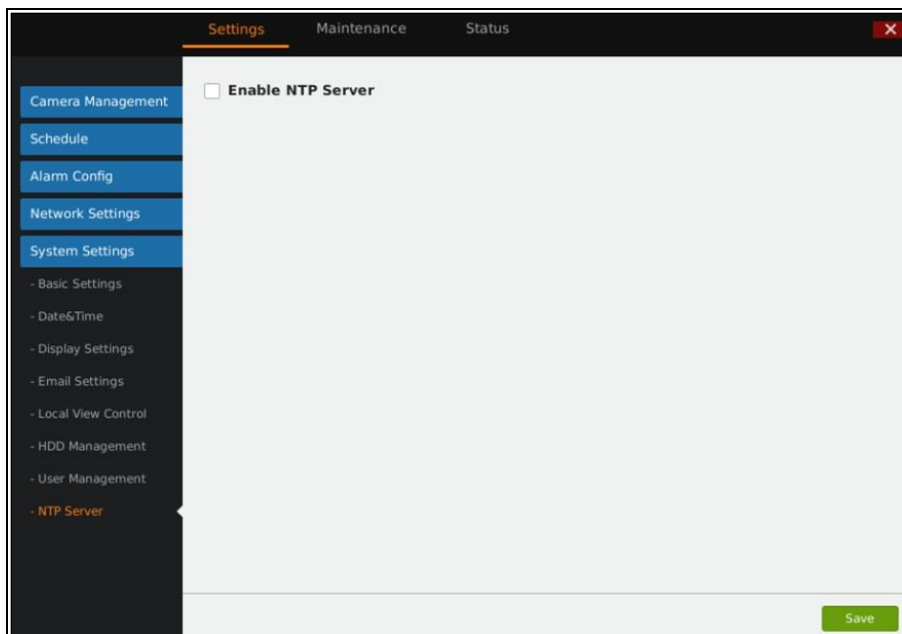

**Figure 66: GVR3550 System Setting Page – NTP Server**

## MAINTENANCE

Users could make operations like Upgrade, Import &Export and Troubleshooting.

## UPGRADE

GVR supports upgrade via TFTP / HTTP / HTTPS and Manual Upload.

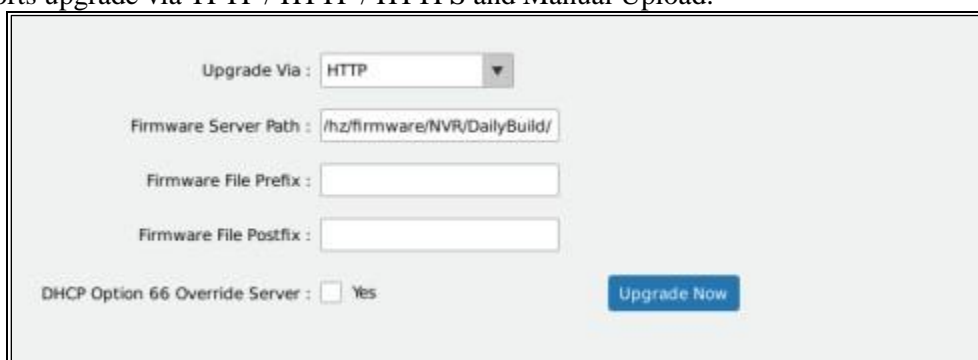

**Figure 67: GVR3550 Update – Via HTTP**

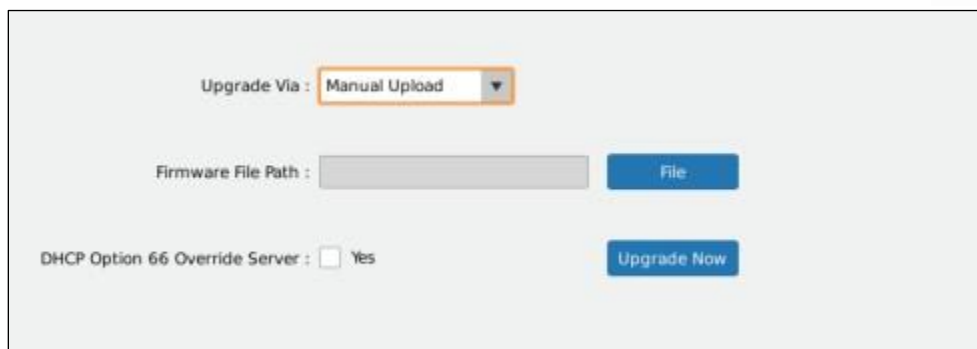

Upgrade Via : Manual Upload ▼

Firmware File Path :  File

DHCP Option 66 Override Server :  Yes Upgrade Now

**Figure 68: GVR3550 Update – Manual Update**

**Table 30: GVR3550 Upgrade Parameter Explanation:**

Parameter	Explanation
<b>Upgrade Via</b>	Firmware upgrade via TFTP / HTTP / HTTPS or Manual Upload. The default settings is " HTTP"
<b>Firmware Server Path</b>	IP address or domain name of upgrade, only available when the upgrade mode is TFTP / HTTP / HTTPS
<b>Firmware File Path</b>	Upgrade firmware by uploading local file
<b>Firmware File Prefix</b>	Enables your ITSP to lock firmware updates. If configured, only the firmware with the matching encrypted prefix will be downloaded and flashed into the phone
<b>Firmware File Postfix</b>	Enables your ITSP to lock firmware updates. If configured, only the firmware with the matching encrypted postfix will be downloaded and flashed into the phone
<b>DHCP Option 66 Override Server</b>	Enable DHCP Option 66.The default is "No". If tick "Yes", the device will obtain IP address and firmware upgrade server address via DHCP (configured via DHCP).The address will override the path the "Firmware Server Path" specifies to fulfill auto deployment. The upgrade will use force TFTP.

## BACKUP

The GVR3550 supports Quick Backup and Search Backup. Users could choose the camera and set the record time for quick backup, and also could set the Record Type, File Type and Record time to search the record file for backup. The backup page is shown in Figure 69 below.

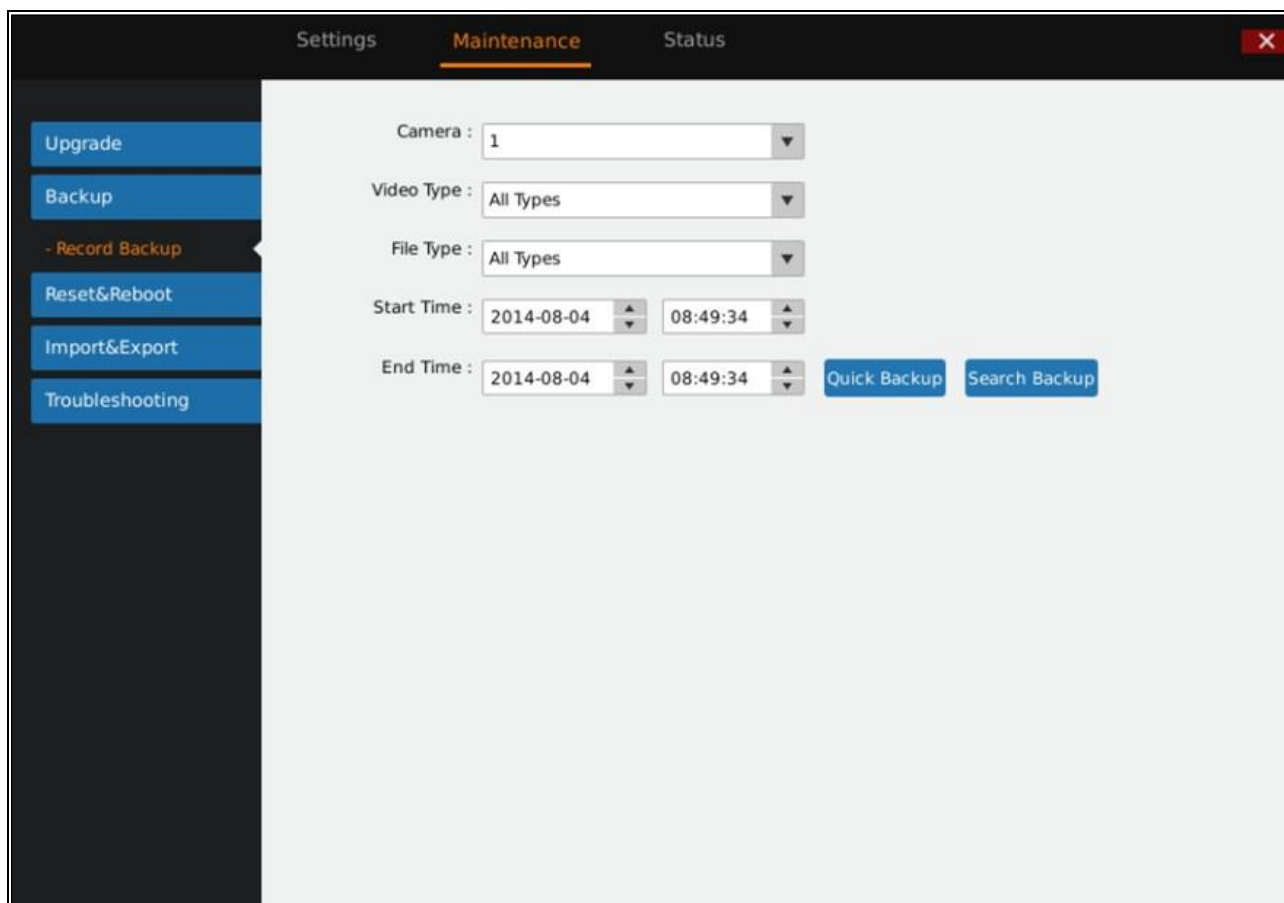

The screenshot shows the 'Maintenance' tab of the GVR3550 web interface. On the left is a navigation menu with options: Upgrade, Backup, - Record Backup (highlighted), Reset&Reboot, Import&Export, and Troubleshooting. The main content area is titled 'Record Backup' and contains the following fields and buttons:

- Camera : 1
- Video Type : All Types
- File Type : All Types
- Start Time : 2014-08-04 08:49:34
- End Time : 2014-08-04 08:49:34
- Buttons: Quick Backup, Search Backup

Figure 69: GVR3550 Backup Page – Record Backup



### **NOTE:**

- Supports up to 1 camera quick backup.
- Quick backup and Search Backup only support local backup but not the remote ones.

## QUICK BACKUP

1. Select the backup camera and set record type, file type, start time and end time, click on the "Quick Backup" Button.
2. Enter the Quick Backup page as shown in Figure 70; refresh the device name to save the backup file.
3. Click on the "Backup" button to enter Backup page as shown in Figure 71 to export all files.

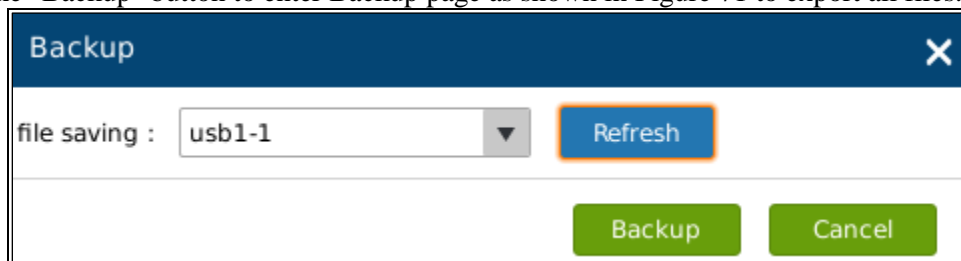

**Figure 70: GVR3550 Backup Page – Quick Backup Page**

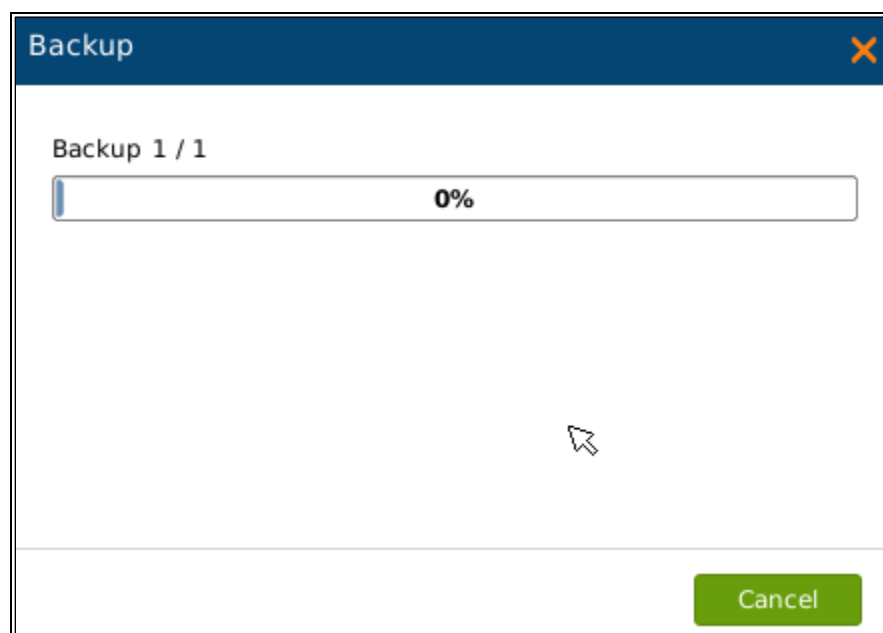

**Figure 71: GVR3550 Backup Page – Quick Backup Progress**

## SEARCH BACKUP

1. Select the backup camera and set record type, file type, start time and end time.
2. Click on the "Search Backup" button to enter the corresponding page as shown in Figure 72 below.  
Users could also click on  to playback the record.
3. Tick the record you want to backup and click on the "Backup" button to enter the backup page to export all files.

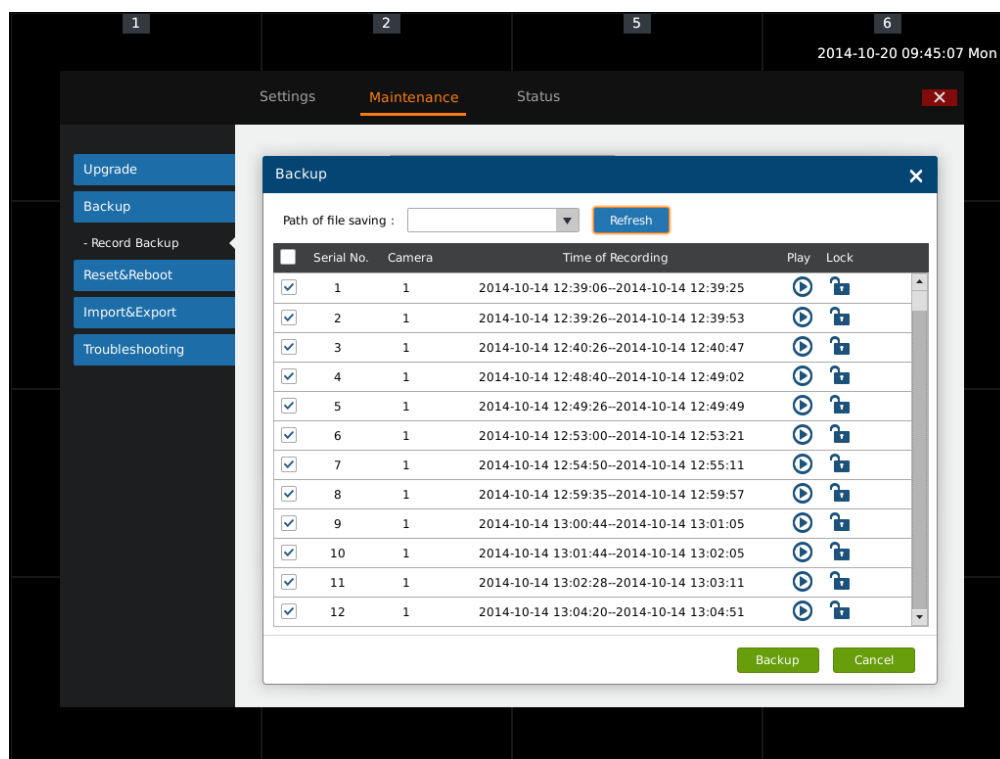

Figure 72: GVR3550 Backup Page – Search Backup



### **NOTE:**

- Please click on the "Refresh" button if the USB device cannot be detected after inserting. If the refresh is invalid, please unplug the USB then insert again. If this try still failed, it might be incompatible with the GVR3550. Please try another USB device instead.
- If the file format of USB device is incorrect, format the device then try again. The GVR3550 supports USB device with FAT 32 format.

## RESET & REBOOT

Users could click the "Reboot" button to boot up, to reset factory settings, users could select "Clear All Data" or "Retain Network Data Only" then click on "Reset" button.

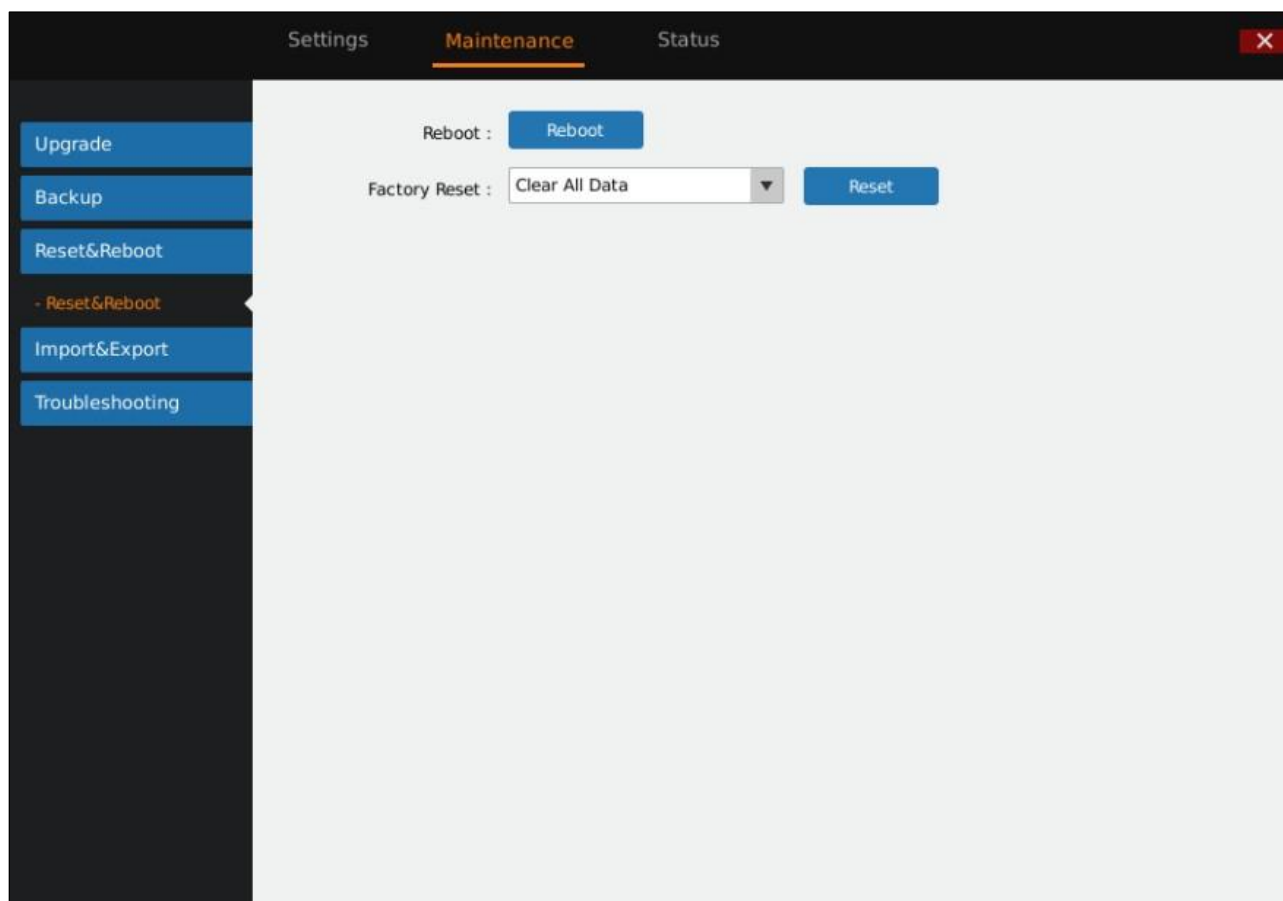

Figure 73: GVR3550 Reset & Reboot Page



### **WARNING!**

- *The GVR3550 data will be erased and set to factory default if enable Factory Reset, please take caution to use this function.*



## IMPORT & EXPORT

The GVR3550 supports import/export configuration file. Users could import the GVR3550 configuration file to external storage device for backup, or import the file to the GVR3550 thus to reduce manual settings procedures. Users could apply backup function if configure the same parameters on multiple devices. The Import/Export page is shown in Figure 74.

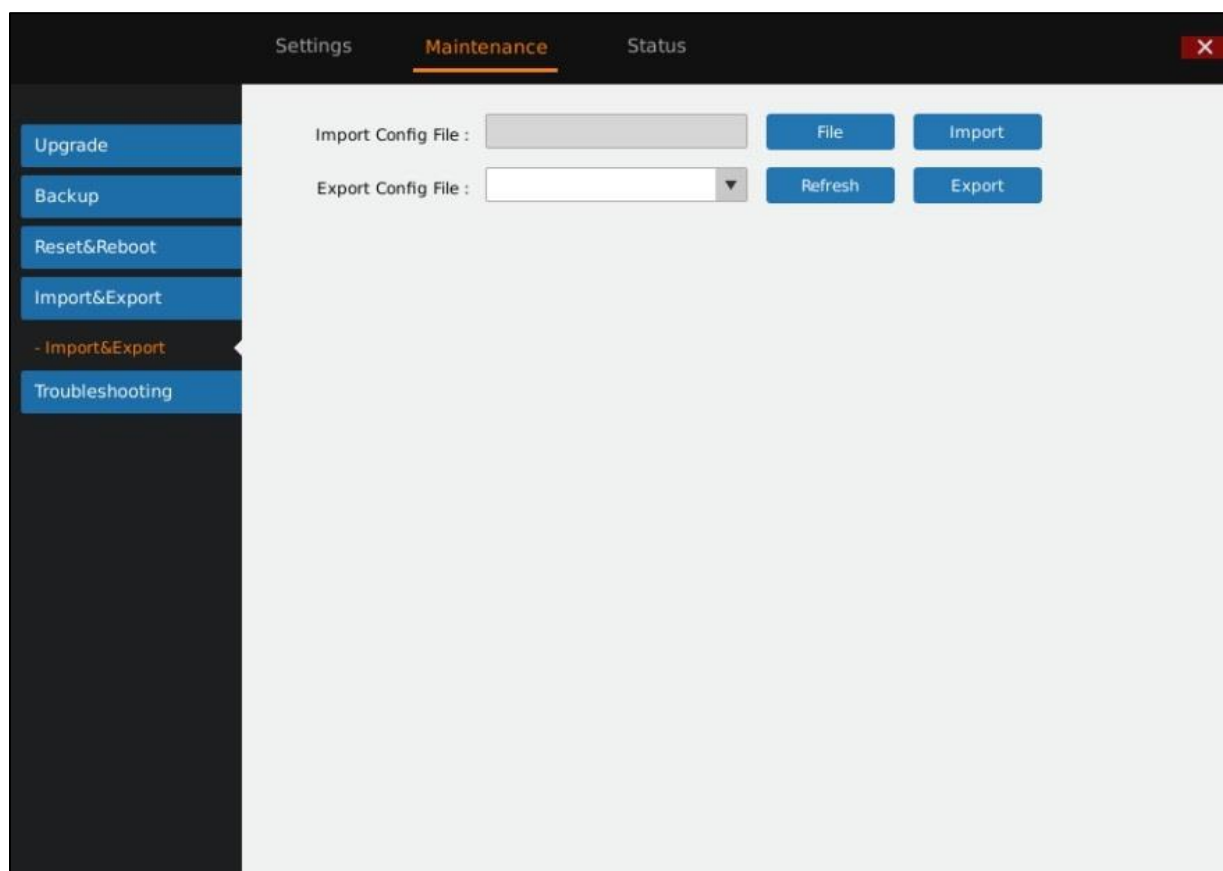

Figure 74: GVR3550 Import & Export Page



### **WARNING!**

- Restart the GVR3550 for the change to take effect after importing configuration file. The original file would be overwritten by the new one, please use this function with caution.

**Table 31: GVR3550 Config File Import & ExportParameter Explanation:**

Parameter	Explanation
<b>Import Configuration File:</b>	Select the configuration file
<i>Select to Import</i>	Click to bring up the warning page, confirm whether to reboot the GVR for the configuration to take effect
<b>Export Configuration File :</b>	Browse to select the path of the Export configuration file
<i>Browse to Export</i>	Click to export the configuration file to the configured external storage device

## TROUBLESHOOTING

Troubleshooting includes Network Diagnosis, System Log and Debug Log.

### NETWORK DIAGNOSIS

Users could make operations like Network Testing, Packet Capture. See Figure 75 below.

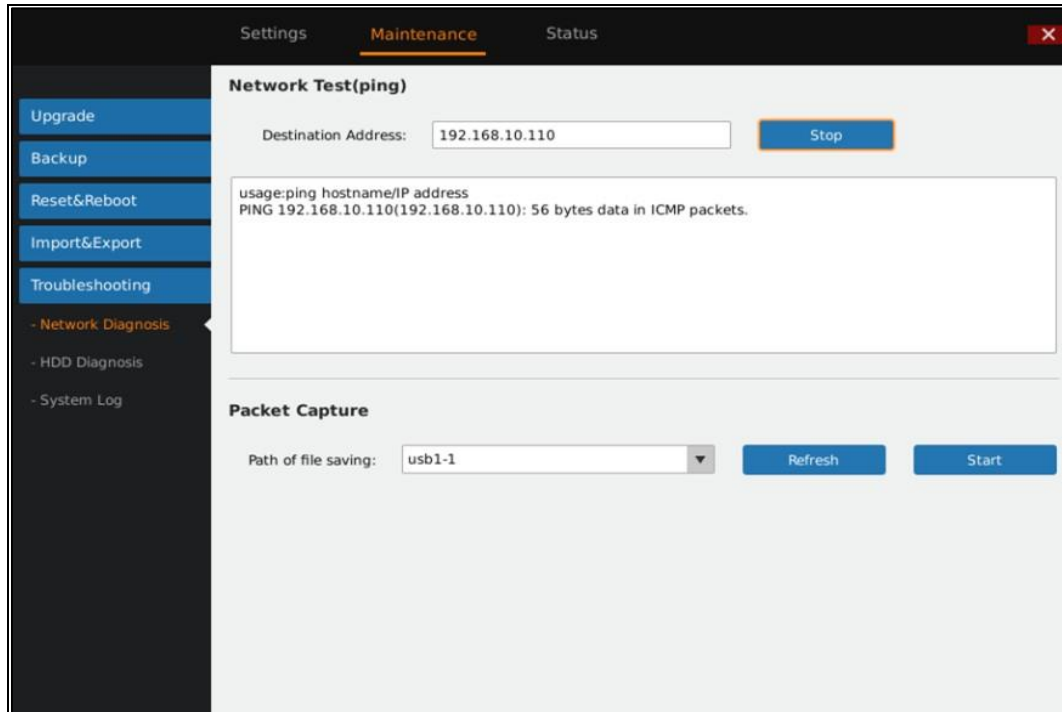

**Figure 75: GVR3550 Troubleshooting Page**

**Table 32: GVR3550 Network Diagnose Parameter Explanation:**

Parameter	Explanation
<b>Network Test (Ping)</b>	Input the destination address, click on "Start" to initiate test, click "Stop" to end test.
<b>Diagnose Output</b>	Display the diagnostic result of GVR3550 and destination IP address.
<u>Path of file saving</u>	Display the external device, users could choose one if there are multiple choices
<u>Refresh</u>	Click to refresh the new access external device.
<u>Start</u>	Click to initiate capture. The capture file will be saved in the directory of selected external device.

### **HDD DETECTION**

The GVR3550 provides S.M.A.R.T. (Self-Monitoring, Analysis and Reporting Technology) Detection and Bad Sector Detection. Users could check HDD running status via HDD detection.

S.M.A.R.T detection provides a variety of detections on HDD heads, temperature, material of disk surface, internal circuit, monitoring and forecasting the underlying problems of HDD that may occur in time.

S.M.A.R.T detection page is as shown in Figure 76 below.

**S.M.A.R.T Detection**

Continue use the HDD after self-test failed

HDD No.:  Detection Type:

HDD Temperature: 37°C Usage Time: 2Days1Hour Detection Status: Not Tested

Evaluation Result: Passed Overall evaluation: Performance Status G

ID	Attribute Name	Flag	Value	Worst	Thresh	Type	Updated	When failed	Raw Value
1	Raw_Read_Error_Rate	0x000b	100	100	062	Pre-fail	Always	-	0
3	Spin_Up_Time	0x0007	214	214	033	Pre-fail	Always	-	1
4	Start_Stop_Count	0x0012	100	100	000	Old_age	Always	-	187
5	Reallocated_Sector_Ct	0x0033	100	100	005	Pre-fail	Always	-	0
7	Seek_Error_Rate	0x000b	100	100	067	Pre-fail	Always	-	0

**Figure 76: GVR3550 S.M.A.R.T. Detection Page**

**Table 33: GVR3550 HDD S.M.A.R.T Detection Parameter Explanation:**

Parameter	Explanation
<b>Continue Using HDD when Self-test Failed</b>	Continue to use the HDD if self-test failed in the process of S.M.A.R.T. detection..
<b>HDD Number</b>	HDD Number 1 - 4 will be allocated in sequence after HDD mounted, The number will not be changed in the subsequence use
<b>Detection Type</b>	Set S.M.A.R.T. Detection type. There are three types: Short, Long, Conveyance
<b>Start</b>	Click the button to initiate S.M.A.R.T. Detection
<b>HDD Temperature</b>	Display the HDD temperature S.M.A.R.T Detection detected.
<b>Usage Time</b>	Display the total usage time of HDD S.M.A.R.T Detection detected
<b>Detection Status</b>	S.M.A.R.T detection Result: Pass or Fail
<b>Evaluation Result</b>	S.M.A.R.T detection evaluation result: Good or Bad
<b>Overall Evaluation</b>	Display the overall HDD status after detection

The HDD bad sector could be detected via Bad Sector Detection as shown in Figure 77 below.



**Figure 77: GVR3550 HDD Bad Sector Detection Page**

**Table 34: GVR3550 HDD Bad Sector Detection Parameter Explanation:**

Parameter	Explanation
<b>HDD Number</b>	HDD Number 1 - 4 will be allocated in sequence after HDD mounted, The number will not be changed in the subsequence use
<b>Start</b>	Click the button to initiate Bad Sector Detection
<b>HDD Capacity</b>	Display the total HDD capacity
<b>Block Capacity</b>	Display the HDD block capacity
<b>Status</b>	Display Bad Sector Detection status: Testing, Test Paused Not Tested.
<b>Error Count</b>	Click the button to check the HDD error info details
<b>Pause/Continue</b>	Pause/Continue Bad Sector Detection
<b>Stop</b>	Stop Bad Sector Detection
<b>Error Info</b>	Display the overall HDD status after detection
<b>HDD Status Display</b>	Tag HDD status with various colors: Good, Damaged, Shield.

## SYSTEM LOG

Users could view the GVR3550 system running state via System Logs. See Figure 78 below.

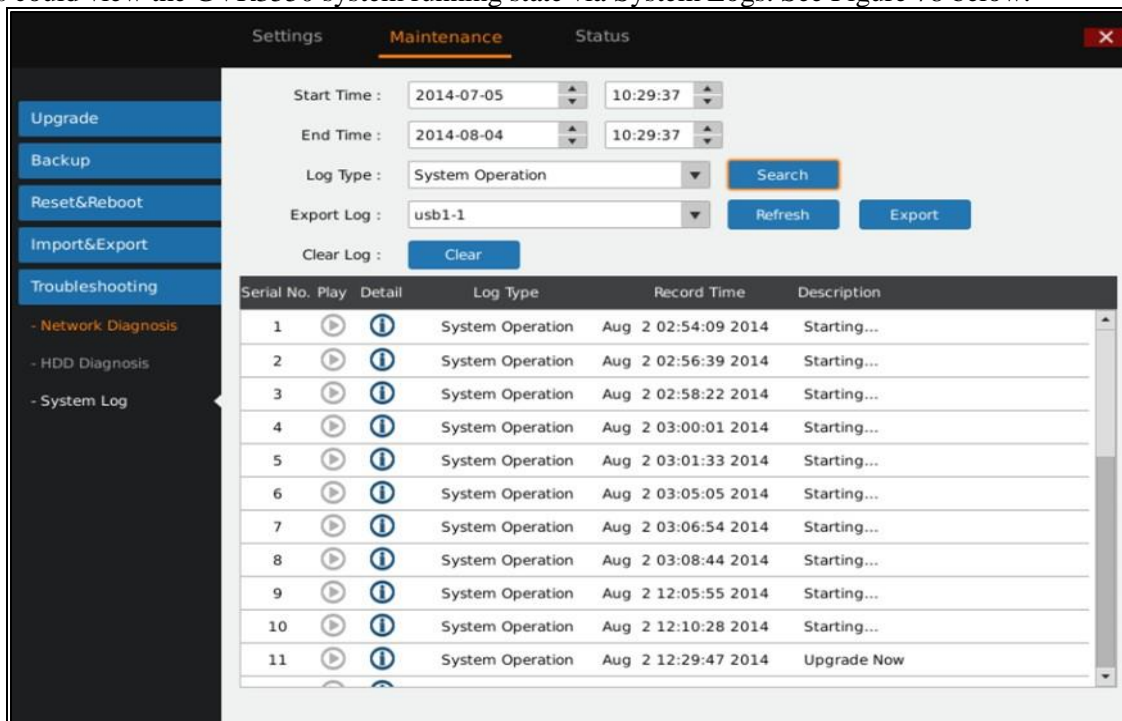

Serial No.	Play	Detail	Log Type	Record Time	Description
1	▶	ⓘ	System Operation	Aug 2 02:54:09 2014	Starting...
2	▶	ⓘ	System Operation	Aug 2 02:56:39 2014	Starting...
3	▶	ⓘ	System Operation	Aug 2 02:58:22 2014	Starting...
4	▶	ⓘ	System Operation	Aug 2 03:00:01 2014	Starting...
5	▶	ⓘ	System Operation	Aug 2 03:01:33 2014	Starting...
6	▶	ⓘ	System Operation	Aug 2 03:05:05 2014	Starting...
7	▶	ⓘ	System Operation	Aug 2 03:06:54 2014	Starting...
8	▶	ⓘ	System Operation	Aug 2 03:08:44 2014	Starting...
9	▶	ⓘ	System Operation	Aug 2 12:05:55 2014	Starting...
10	▶	ⓘ	System Operation	Aug 2 12:10:28 2014	Starting...
11	▶	ⓘ	System Operation	Aug 2 12:29:47 2014	Upgrade Now

**Figure 78: GVR3550 System Log Page**

**Table 35: GVR3550 Sys Log Parameter Explanation:**

Parameter	Explanation
<b>Start Time</b>	System log search start time
<b>End Time</b>	System log search end time
<b>Log Type</b>	Includes: All Types, System Operation, Configure Operation, Data Management, Alarm Event, Recording Operation, User Management, Clear Log and File Operation
<b>Search</b>	Click to search log that meets search criteria and display it in the log list
<b>Export Log</b>	GVR3550 supports exporting the searched log and saving it to the external storage device. Select the log file from the drop-down list and save it to the target path
<b>Browse</b>	Click to browse and select the destination for log export
<b>Export</b>	Click to export the log file and save it to the selected target path
<b>Clear Log</b>	Click "Clear" to clear syslog
<b>Playback</b>	For alarm log, click the blue playback button before the log can get into replay mode to play back the alarm video
<b>Details</b>	Click to open the detailed log information

# STATUS

Status includes Recording Info, System Info, Network Info, Resource Usage, Alarm Info and HDD Info.

## RECORDING INFO

User could view the connected camera status and the schedule record on GVR. See Figure 79 below.

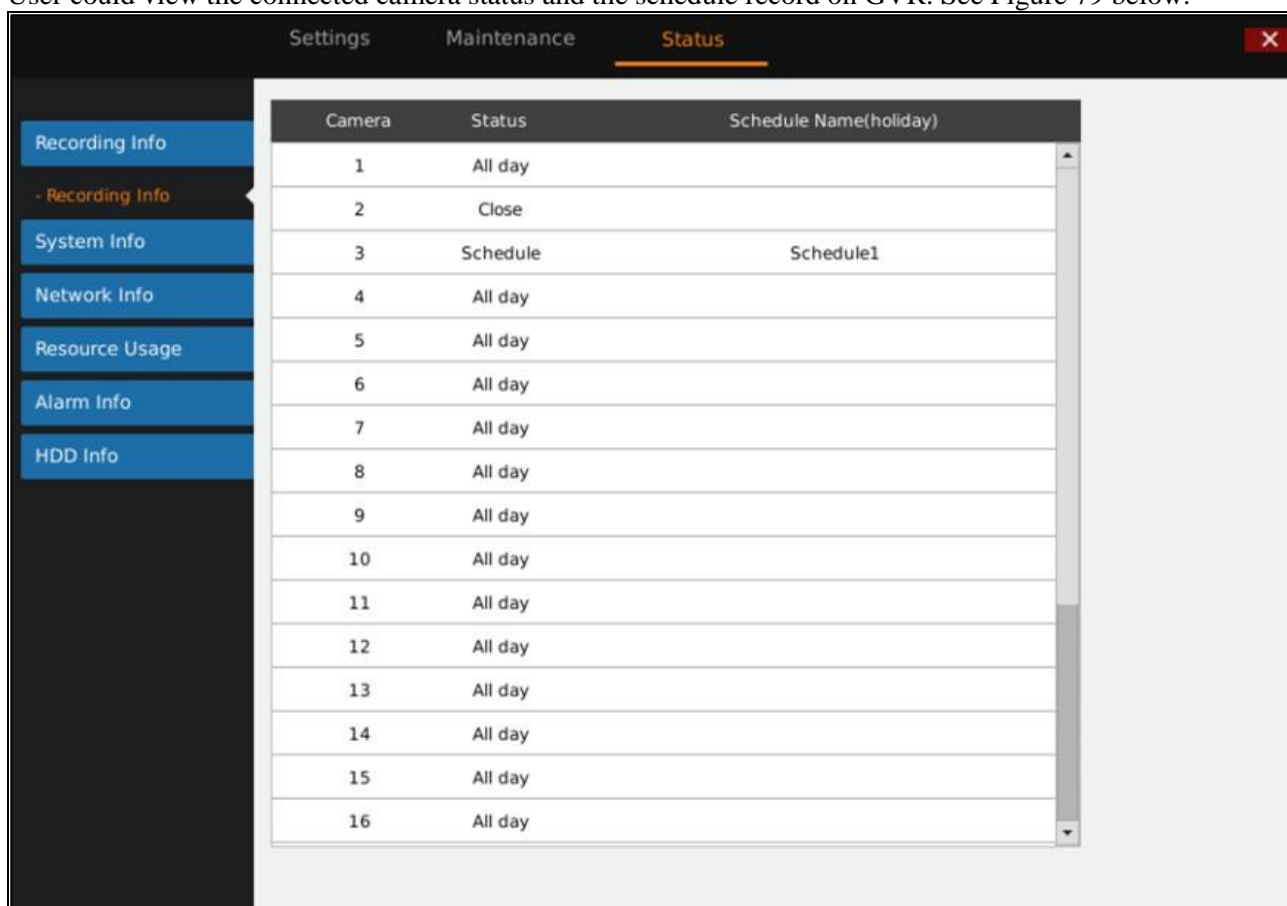

Camera	Status	Schedule Name(holiday)
1	All day	
2	Close	
3	Schedule	Schedule1
4	All day	
5	All day	
6	All day	
7	All day	
8	All day	
9	All day	
10	All day	
11	All day	
12	All day	
13	All day	
14	All day	
15	All day	
16	All day	

Figure 79: GVR3550 Recording Info Page

## SYSTEM INFO

Users could view the GVR System info like part number and hardware version as shown in Figure 80 below.

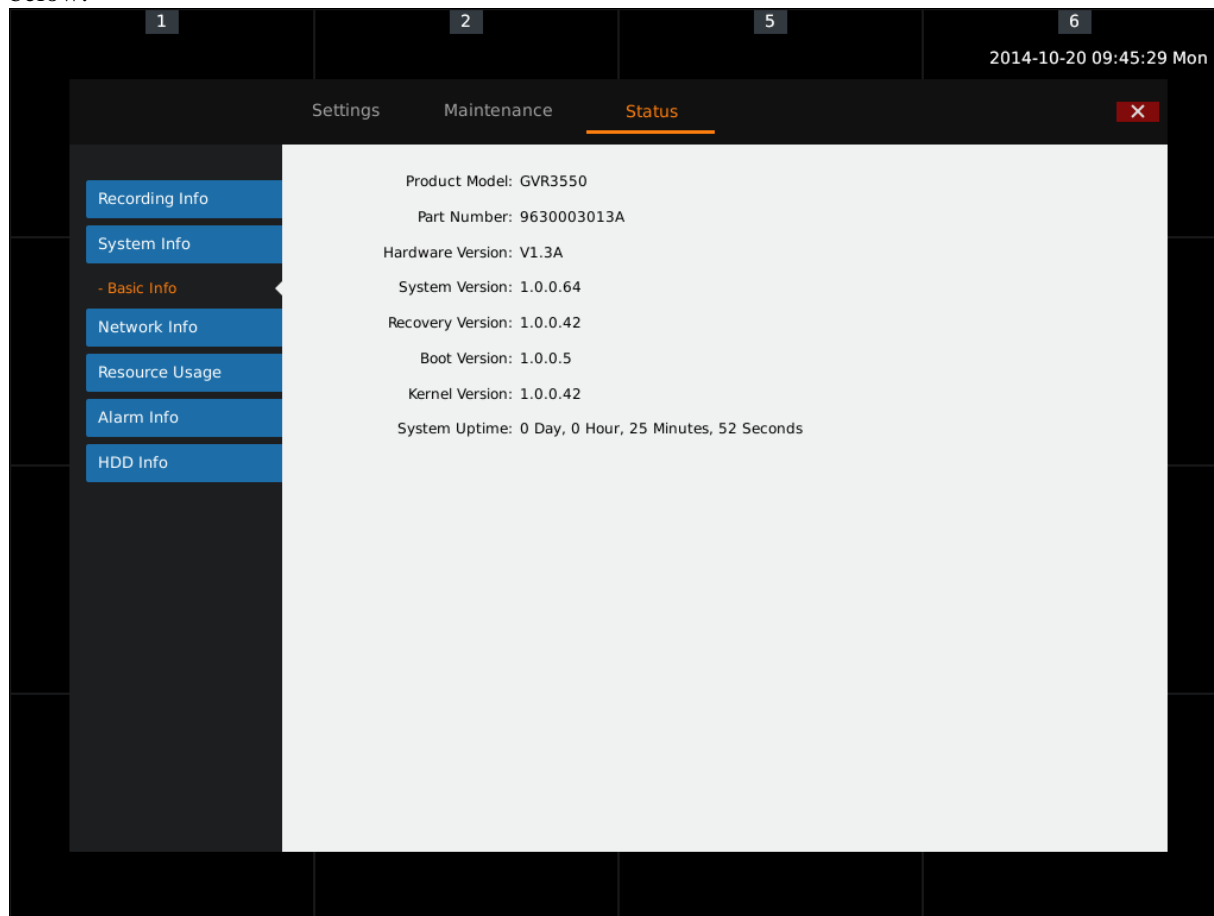

**Figure 80: GVR3550 HDD System Info Page**



## NETWORK INFO

Users could view network status includes Address Type and IP Address. As shown in Figure 81.

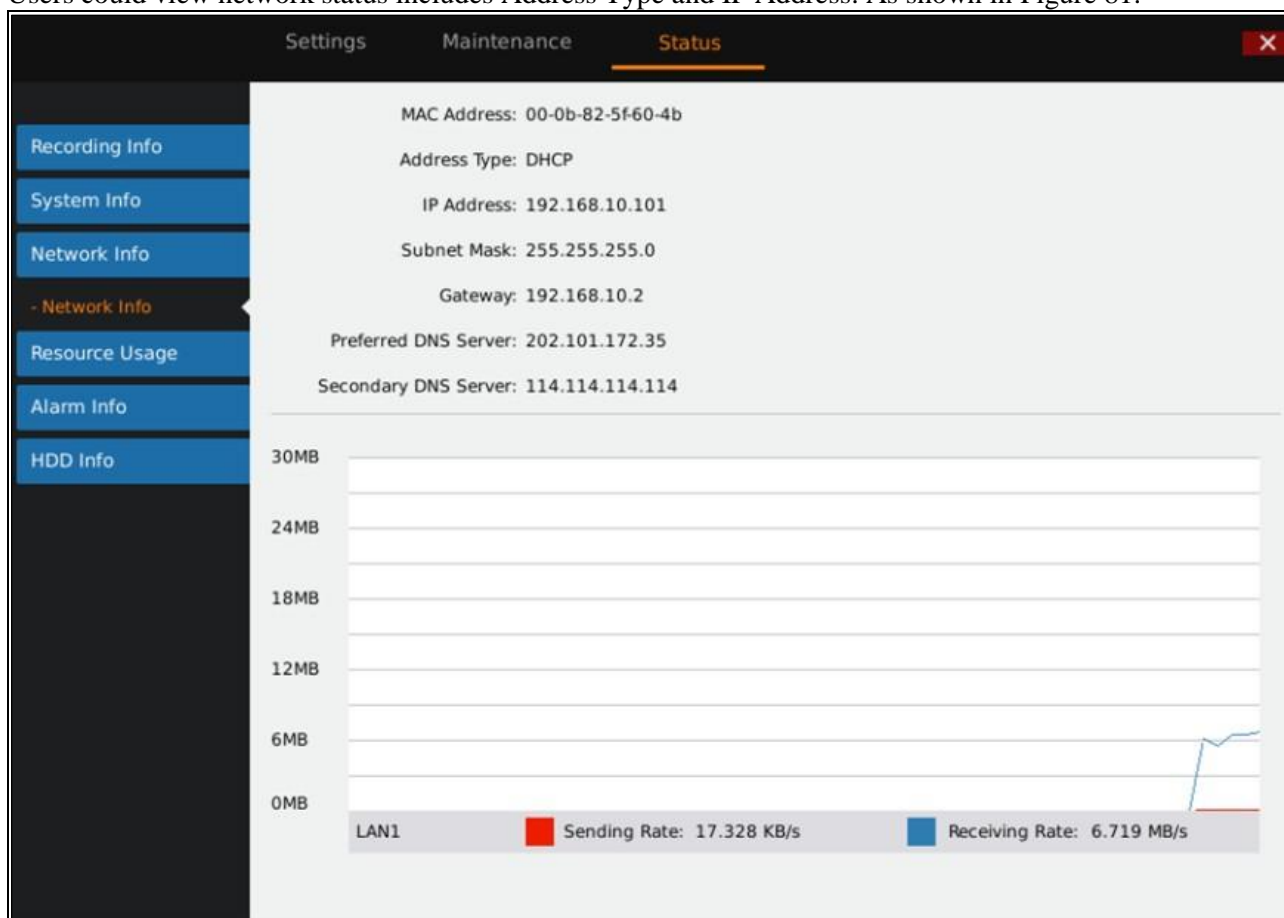
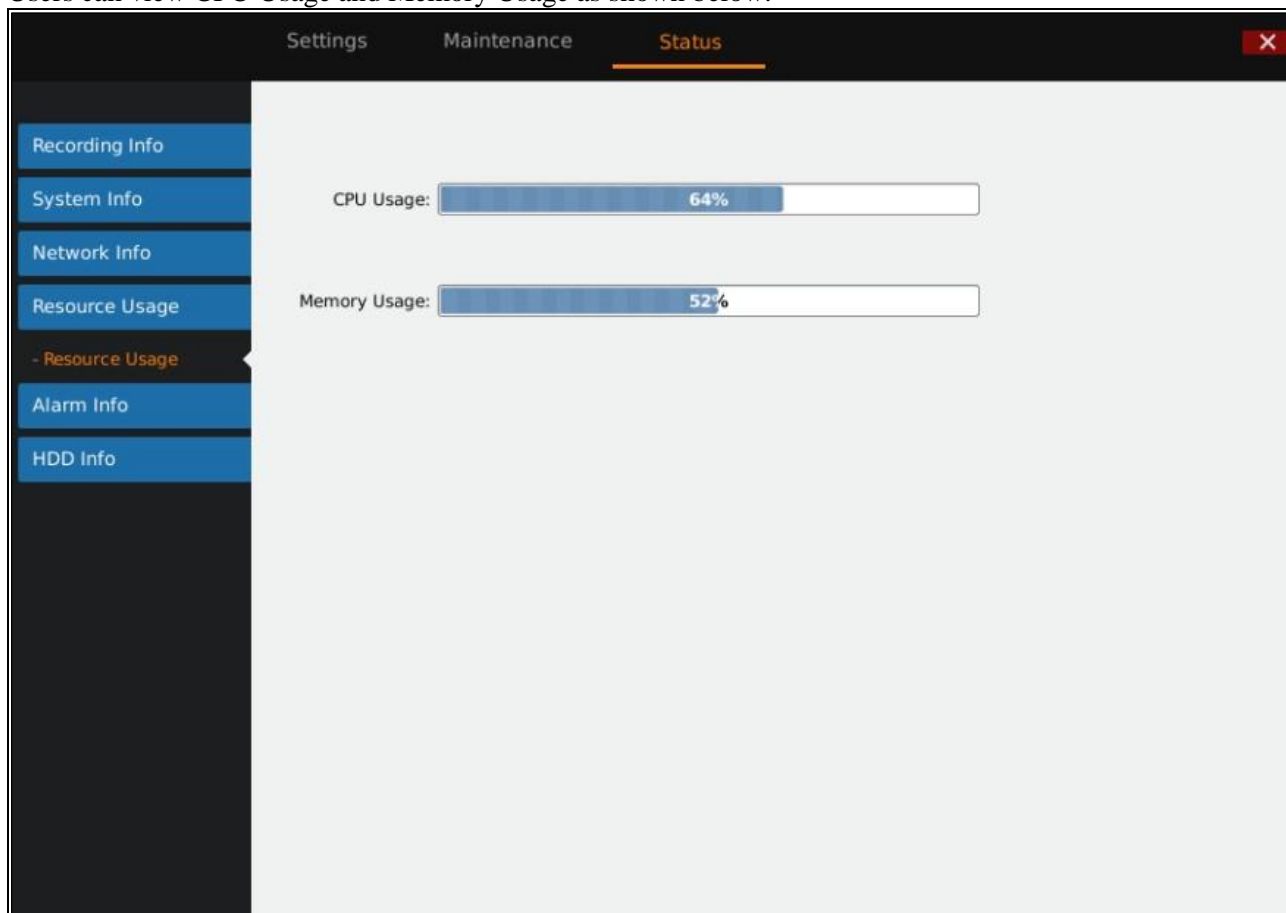

Figure 81: GVR3550 HDD Network Info Page

## RESOURCE USAGE

Users can view CPU Usage and Memory Usage as shown below.



**Figure 82: GVR3550 HDD Resource Usage Page**

**Table 36: GVR3550 Device Status Parameter Explanation:**

Parameter	Explanation
<b>CPU Usage</b>	Real-time display the CPU usage of the GVR3550.
<b>Memory Usage</b>	Real-time display the memory usage of the GVR3550.

## ALARM INFO

Users can view the alarm type of configured cameras. As shown in Figure 83 below.

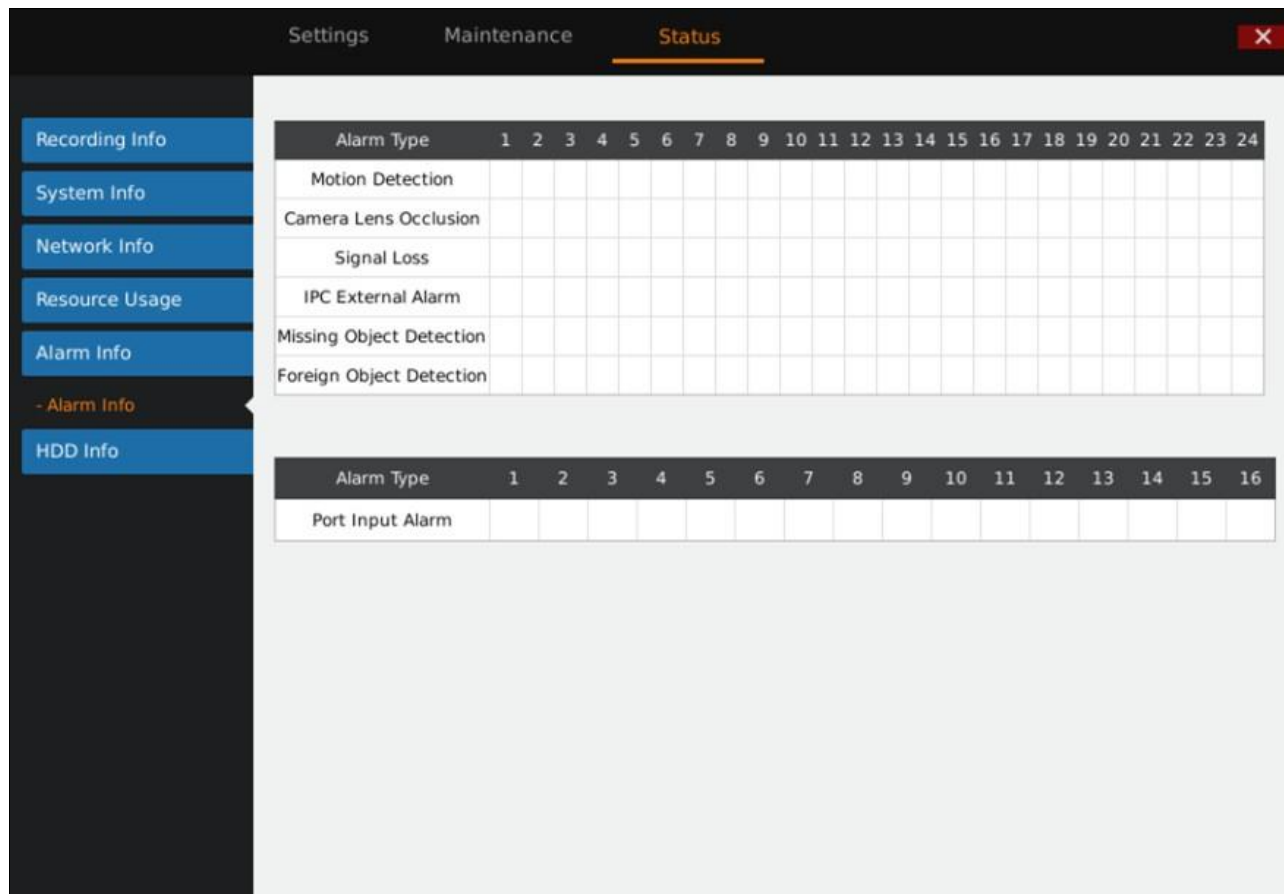

The screenshot shows the 'Status' page of the GVR3550 interface. The sidebar on the left contains the following menu items: Recording Info, System Info, Network Info, Resource Usage, Alarm Info (highlighted), - Alarm Info, and HDD Info. The main content area displays two tables of alarm status.

Alarm Type	1	2	3	4	5	6	7	8	9	10	11	12	13	14	15	16	17	18	19	20	21	22	23	24
Motion Detection																								
Camera Lens Occlusion																								
Signal Loss																								
IPC External Alarm																								
Missing Object Detection																								
Foreign Object Detection																								

  

Alarm Type	1	2	3	4	5	6	7	8	9	10	11	12	13	14	15	16
Port Input Alarm																

Figure 83: GVR3550 Alarm Info Page

## HDD INFO

Users can view HDD No., Attribution Volume, Serial No., Total Space and HDD Status. As shown in Figure 84 below.

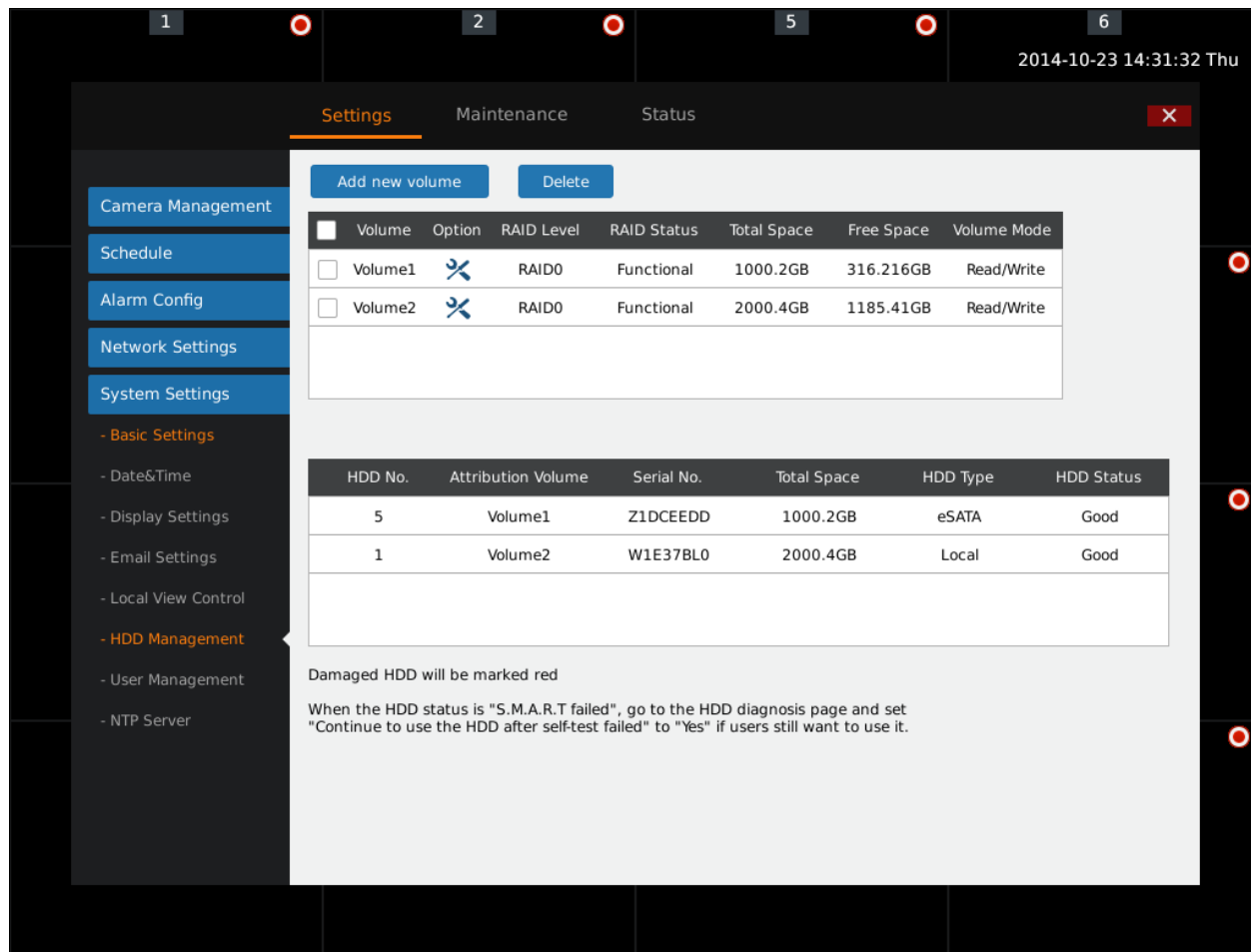

The screenshot shows the 'Settings' page for the GVR3550. The left sidebar contains navigation options: Camera Management, Schedule, Alarm Config, Network Settings, System Settings, - Basic Settings, - Date&Time, - Display Settings, - Email Settings, - Local View Control, - HDD Management, - User Management, and - NTP Server. The main content area has tabs for Settings, Maintenance, and Status. Under the Settings tab, there are buttons for 'Add new volume' and 'Delete'. Below these are two tables.

<input type="checkbox"/>	Volume	Option	RAID Level	RAID Status	Total Space	Free Space	Volume Mode
<input type="checkbox"/>	Volume1		RAID0	Functional	1000.2GB	316.216GB	Read/Write
<input type="checkbox"/>	Volume2		RAID0	Functional	2000.4GB	1185.41GB	Read/Write

HDD No.	Attribution Volume	Serial No.	Total Space	HDD Type	HDD Status
5	Volume1	Z1DCCEEDD	1000.2GB	eSATA	Good
1	Volume2	W1E37BL0	2000.4GB	Local	Good

Damaged HDD will be marked red

When the HDD status is "S.M.A.R.T failed", go to the HDD diagnosis page and set "Continue to use the HDD after self-test failed" to "Yes" if users still want to use it.

Figure 84: GVR3550 HDD Info Page

## LOGOUT

The GVR3550 would display preview status after logout, please input username/password to login for authentication when entering the menu again.

# WEB MANAGEMENT

## OVERVIEW

The GVR3550 supports accessing and managing GVR on the web page via the remote PC. The Web page provides operations like Record playback & Search, Record Settings, Alarm Settings, System Settings, PTZ Control, most operations are the same as on local GUI.



### **NOTE:**

- *The following chapters are only to specify the operations differ from local GUI. Please refer to the chapters of local GUI for other operations.*

## SYSTEM LOGIN

This chapter introduces how to login the GVR3550 Web page via Web browser like Microsoft's IE, Mozilla Firefox and Google Chrome.

1. Access a network;
2. Go to Main Menu->Status->Network Status to detect the GVR IP address when it runs normally;
3. Open a web browser and enter the GVR3550 IP address in the address bar, e.g.: <http://192.168.10.101>. (The default port No. is 80);
4. Press the "Enter" button to enter the GVR3550 Web Login page, input the username and password in the prompt box. The default administrator username and password are admin, admin. Please modify the password after login without delay;
5. Select the language in the drop-down menu. Chinese and English are supportive;
6. Click the "Login" button to enter the Web page.



*Figure 85: GVR3550 Web Page – Login*

### **WEB PAGE INTRODUCTION**

Users can switch among live View, Playback, Settings, Maintenance and Status, set language or logout.



*Figure 86: GVR3550 Web Page – System Menu*

## LIVE VIEW

Users need to download and install the video playback plug-in "GVRView.exe" first before making live View operations on the Web page. Refresh the webpage after downloading the plug-in. If the PC has installed the plug-in before, the system will prompt to close the browser to install it. Remote live view page is shown in Figure 87 below.

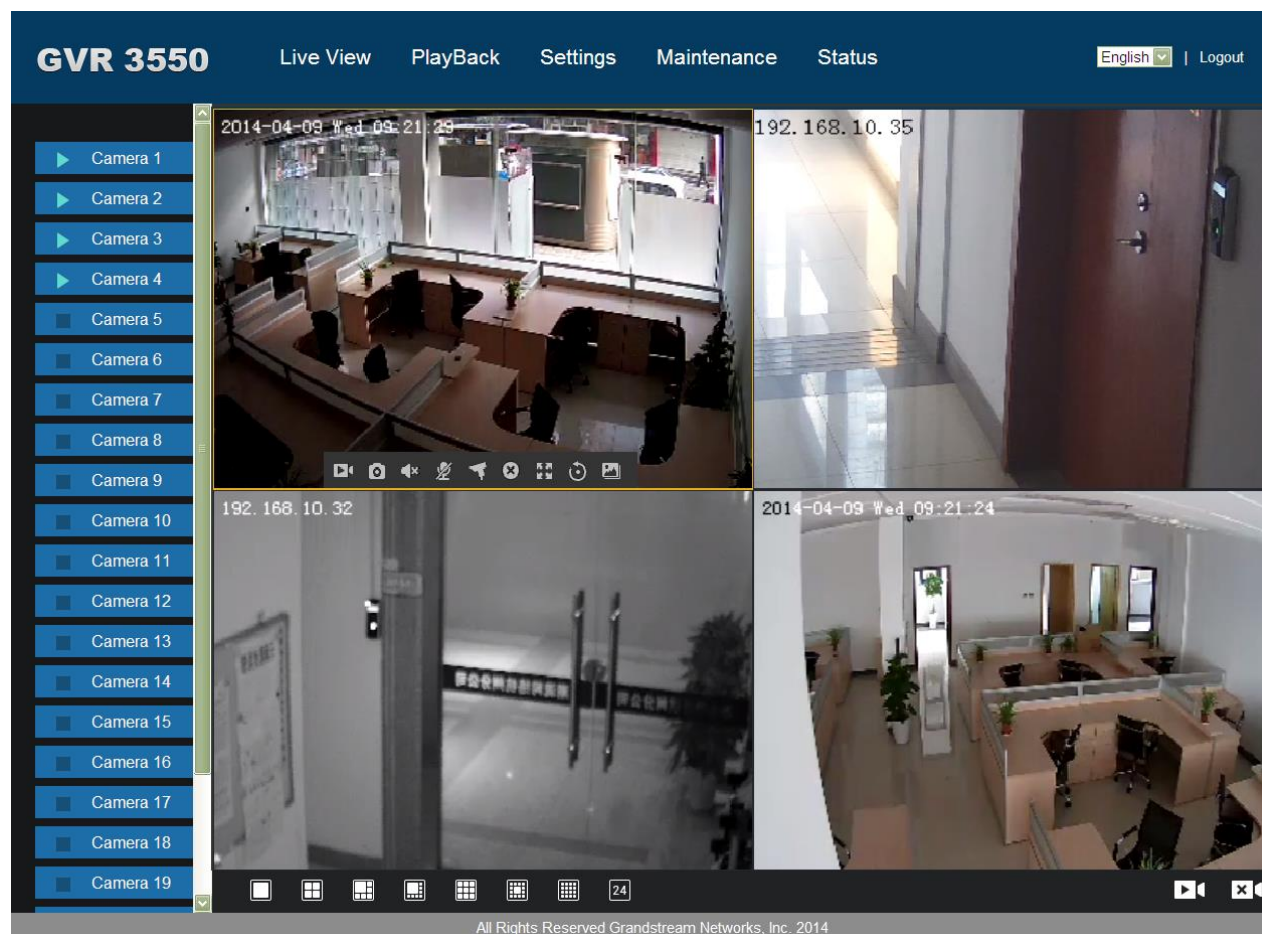





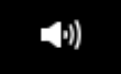







**Figure 87: GVR3550 Web Real-time View Page**

Users can find the added cameras in the camera list on the left side of the page, double click one camera name to add it to the view screen or click on  in the lower right corner to initiate view all screens. Remote live view supports up to synchronous 16 cameras.

Multiple screen can be manipulated via the options on the bottom of the screen, such as 1 window, 4 window, 9 window, 16 window, 24 window.

Double click on one camera to check the live view and set basic settings.

**Table 37: GVR3550 Remote Preview Operation Explanation:**

#	Icon	Name	Explanation
1		<b>Closed Record</b>	The camera is not recording now
		<b>Manual Record</b>	The camera is in manual record mode. The default path: C:\GVR_Record
2		<b>Capture</b>	The external storage devices (USB) need to be connected first. Users could configure the save path and set it to default C:\GVR_Capture.
3		<b>Mute/Unmute</b>	Unmute to listen audio from remote IP Camera if the IP Camera has microphone connected.
			Mute to stop the audio.
4		<b>Start/Stop Intercom</b>	Start to allow audio input from PC to play out at remote IP camera if remote IP camera has audio output device connected (e.g.: Speaker).
			Stop to disable this process.
5		<b>PTZ Control</b>	Enable basic PTZ operations preset PTZ preset, patrol, pattern
6		<b>Switch to Full Screen</b>	Switch the current screen to full screen or double click to enter full screen mode
			
7		<b>Instant Playback</b>	Playback the record in the preset time. It will prompt "The selected camera has no record "if has no existing record. Users could set the preset time in Basic System Settings chapter
8		<b>Image Config</b>	Open configure interface to adjust current image
9		<b>Close Preview</b>	Close the preview window

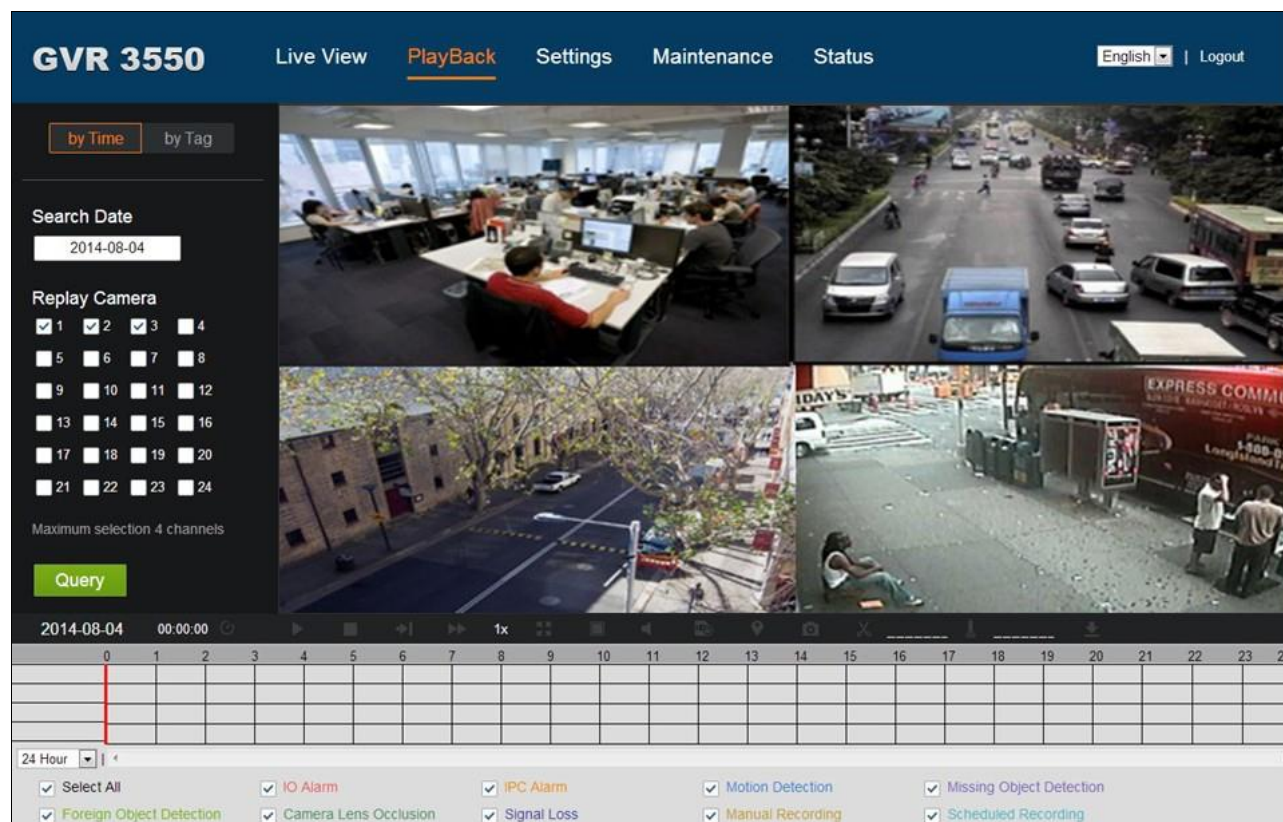

**Table 38: GVR3550 Remote Preview Camera Information Explanation:**

#	Name	Explanation
1	<b>Camera Name</b>	Display the camera name, it would not be displayed if not configured.
2	<b>Date &amp;Time</b>	Display the current time, it would not be displayed if not configured
3	<b>Camera Stream</b>	Click right mouse to enter the stream settings page to view camera stream or tick to set primary stream or secondary stream.
4	<b>Record Status</b>	Display the current camera record status (being recorded or not).

## PLAYBACK

Please refer to the chapter *Local Playback* to view remote playback on Web page. It should be noted that the record which could be searched on the Web page is the one stored in the GVR3550 HDD, snapshots and clips could only be saved in PC but not on local GUI. The playback on the Web page is as shown in Figure 88 below.



**Figure 88: GVR3550 Web Playback Page**

## SETTINGS

Please refer to chapter **Main Menu** to set settings on the Web page. It should be noted that the path to save snapshots and clips are only for the Web page, the related files are saved in PC and users could not make operations on Local GUI.

Put the cursor on ⓘ to view the parameters.

## BASIC SYSTEM SETTINGS

The Basic System Settings on the Web page is as shown below, please refer to chapter **Basic System Settings** to view other parameters settings, record & playback clips save path and Instant playback Start time (min) can only be set to the local path in PC.

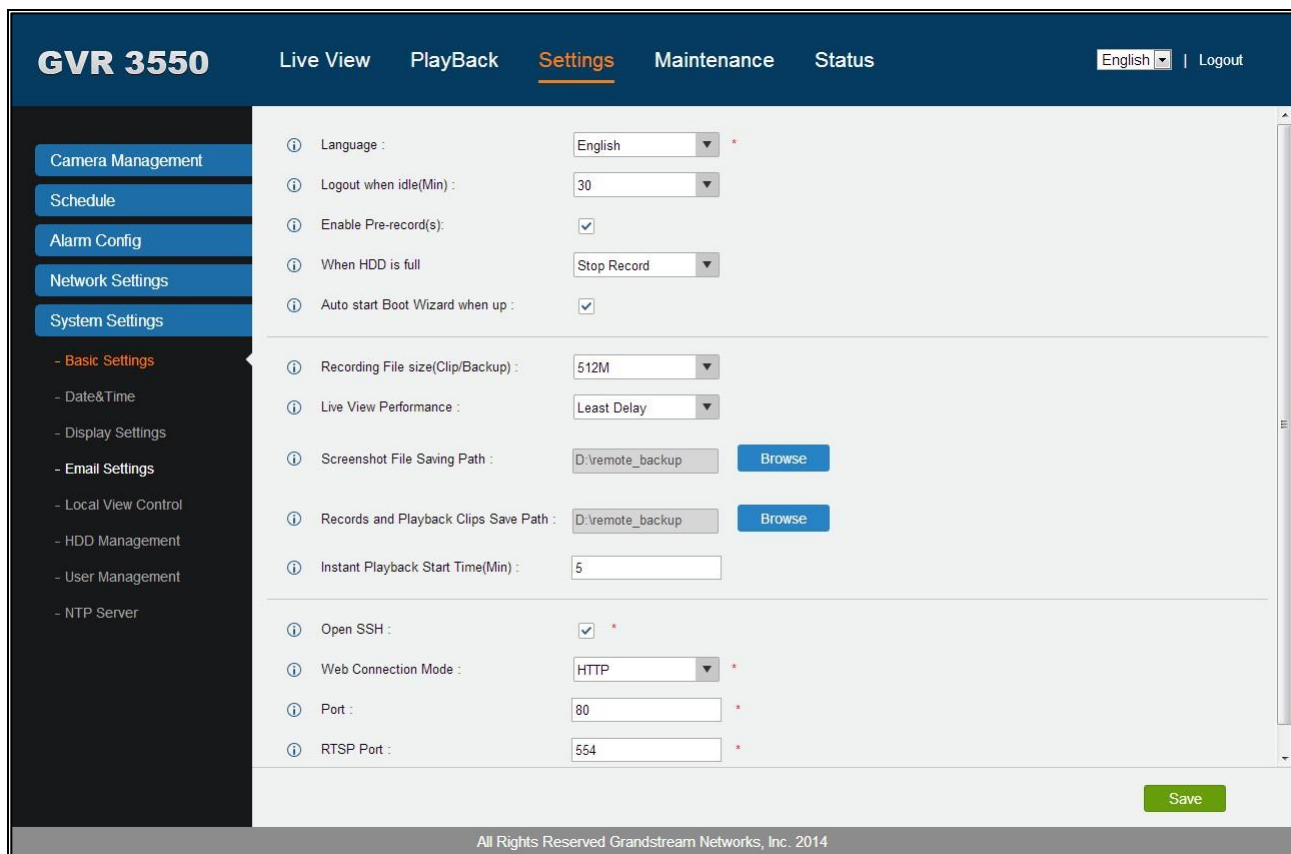

**GVR 3550** Live View Playback **Settings** Maintenance Status English | Logout

- Camera Management
- Schedule
- Alarm Config
- Network Settings
- System Settings
  - Basic Settings
  - Date&Time
  - Display Settings
  - Email Settings
  - Local View Control
  - HDD Management
  - User Management
  - NTP Server

ⓘ Language : English \*  
 ⓘ Logout when idle(Min) : 30  
 ⓘ Enable Pre-record(s):   
 ⓘ When HDD is full : Stop Record  
 ⓘ Auto start Boot Wizard when up :

---

ⓘ Recording File size(Clip/Backup) : 512M  
 ⓘ Live View Performance : Least Delay  
 ⓘ Screenshot File Saving Path : D:\remote\_backup [Browse](#)  
 ⓘ Records and Playback Clips Save Path : D:\remote\_backup [Browse](#)  
 ⓘ Instant Playback Start Time(Min) : 5

---

ⓘ Open SSH :  \*  
 ⓘ Web Connection Mode : HTTP \*  
 ⓘ Port : 80 \*  
 ⓘ RTSP Port : 554 \*

[Save](#)

All Rights Reserved Grandstream Networks, Inc. 2014

**Figure 89: GVR3550 Web Page – System Settings**

## DEBUG LOG

The Maintenance on the Web page is shown in Figure 90 below. Please refer to chapter **Maintenance** to view other parameters settings. Users could set Upgrade, Import &Export, and Troubleshooting on the maintenance page.

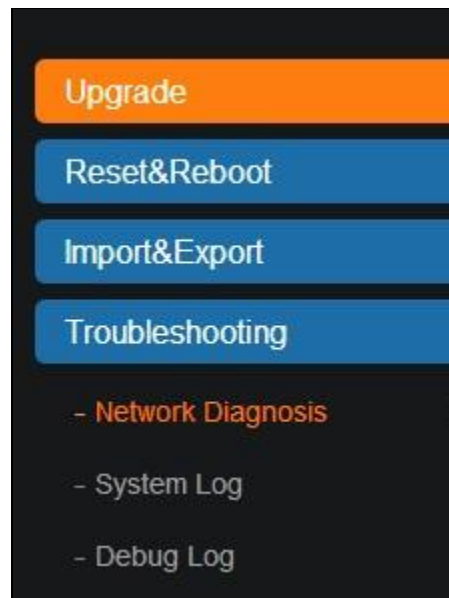

**Figure 90: GVR3550 Web Page – Maintenance Menu**

Go to Maintenance->Troubleshooting-> Debug Log to set debug parameters.



**Figure 91: GVR3550 Web Page – Debug Log**

**Table 39: GVR3550 Debug Log Parameter Explanation:**

Parameter	Explanation
<b>Debug Log Server</b>	The IP address or URL of the debug log server.
<b>Debug Log Level</b>	<p>Selects the log level. The default setting "None" means sending no log. The log priority from high to low is Debug, Info, Warning and Error.</p> <p>Debug Log based on the following events:</p> <ul style="list-style-type: none"> <li>The product model/version (INFO level)</li> <li>NAT Info (INFO level)</li> <li>Registration state changes (INFO level)</li> <li>Negotiation coding (INFO level)</li> <li>Ethernet connection (INFO level)</li> <li>SLIC debris abnormal (WARNING and ERROR level)</li> <li>Abnormal memory (ERROR level)</li> </ul>

### **STATUS - QR CODE**

Users could quickly add the GVR directly via scan QR code. Please refer to the Grandstream Website <http://www.grandstream.com> for more client details.

## FIRMWARE UPDATE

The GVR3550 supports software upgrade via TFTP /HTTP/HTTPS server. Please go to Maintenance ->Upgrade to configure.

The GVR3550 supports the following update modes:

- Manual upload the firmware file to update
- Upgrade via TFTP firmware server
- Upgrade via HTTP/HTTPS firmware server



### **NOTE:**

- It is **HIGHLY** recommended that use an Uninterruptible Power Supply (UPS) or it might be fail if emergency cutoff in the process of update.
- Please unpack the compression package before upgrade when manual update.

### **DOWNLOAD CONFIGURATION FILE**

Besides the Web page, the Grandstream GVR could also be configured with load the configuration file (Binary file or XML file) via TFTP / HTTP/HTTPS. "Configure Server Path" refers to the TFTP/HTTP/HTTPS server path that saves the configuration file. A valid URL/FQDN/IP address should be configured. "Configure Server Path" could be differ from or the same as "Firmware Server Path".

Configuration file download address: <http://www.grandstream.com/support/firmware>

### **CONFIGURING SERVER**

If have no local TFTP server, users could use HTTP server that supports NAT provided by the Grandstream. Connect to the server to upgrade firmware.

Grandstream Firmware server address: <http://www.grandstream.com/support/firmware>

Users could also download the free TFTP /HTTP/HTTPS server by visiting the link below to download free Windows TFTP server :

[http://www.solarwinds.com/register/?program=52&c=7015000000CcH2&INTCMP=DLIndexA\\_FreeTools\\_freeTFTPserver](http://www.solarwinds.com/register/?program=52&c=7015000000CcH2&INTCMP=DLIndexA_FreeTools_freeTFTPserver)

Users could download the free HTTP server from <http://httpd.apache.org/>, or use Microsoft IIS network server.

## CONFIGURING TFTP SERVER

In this chapter, we take 3CDAemon TFTP server as an example.

1. Open the TFTP server as shown in figure below;

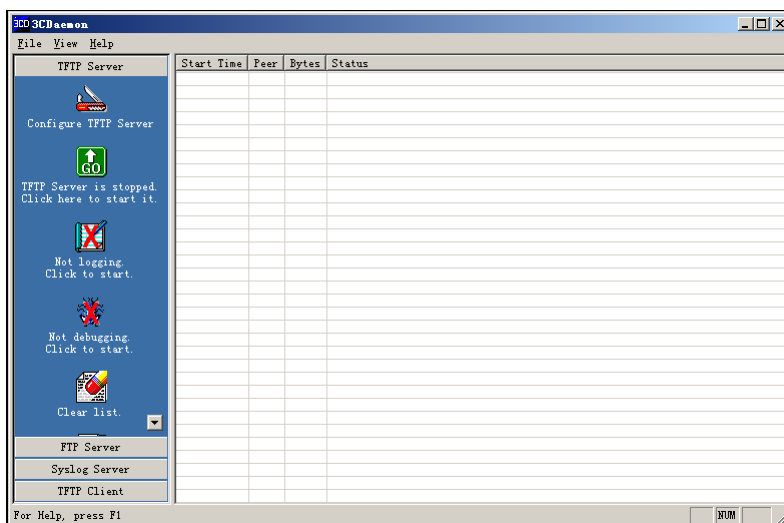

Figure 92: TFTP Server Page

2. Click "Configure TFTP Server" on the TFTP Server page as shown in Figure 93 below;

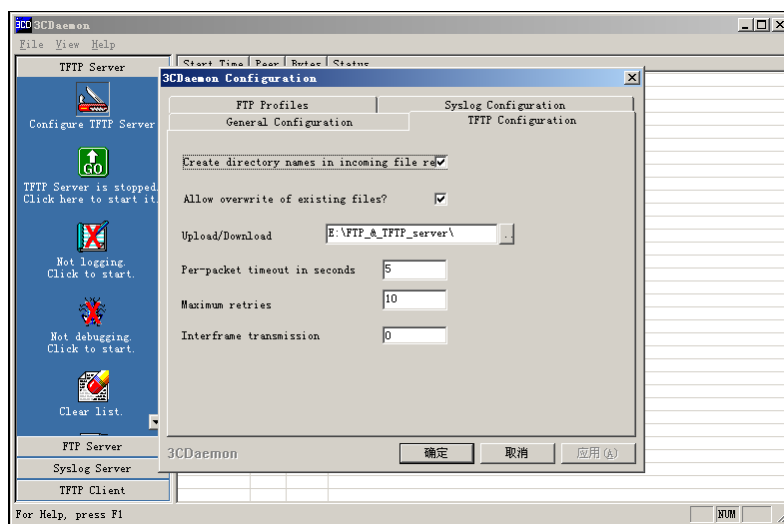
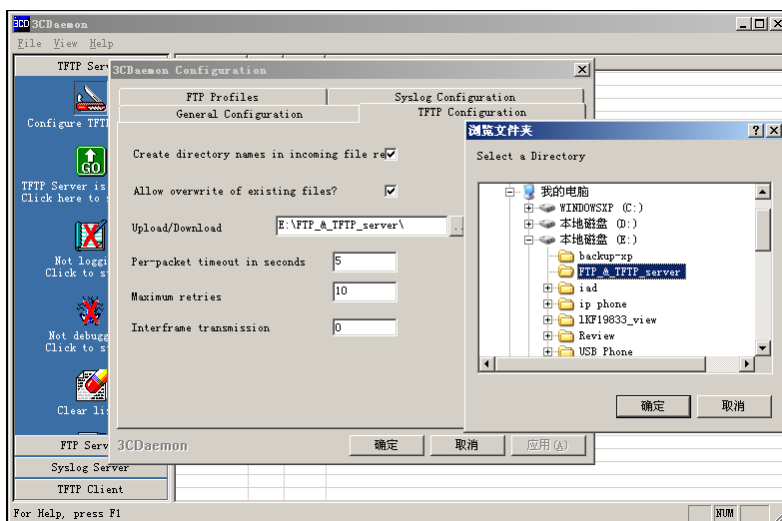

Figure 93: TFTP Dialog

3. Set the directory to save the loaded file in "Upload/Download" entry under TFTP Configuration tab, as shown in Figure 94 below;



**Figure 94: TFTP Server Directory Settings**

4. Select the file storage directory and click "Apply" to bring up the dialog box as shown in Figure 95 below.

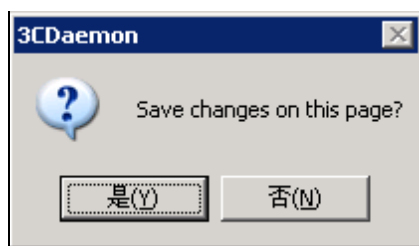

**Figure 95: Confirm Modification**

5. Click "Yes" to confirm modification;
6. Click "Confirm" to close the configuration dialog.





**NOTE:**

*The file uploaded to the server directory should be the .bin file after unzip.*

## CONFIGURING HTTP SERVER

In this chapter, we take using Apache HTTP Server2.2 server in windows XP to introduce the procedures of configuring HTTP server.

Users could obtain the Apache HTTP server installation software via <http://httpd.apache.org>, please finish the default installation according to the wizard.

1. Enable Apache server. Go to Start ->All Programs ->Apache HTTP Server 2.2 -> Monitor Apache Servers in a PC which has installed with the Apache server. The icon  in the notification area of taskbar indicates Apache server is already enabled. If displays , select "Start" to enable the server;
2. Put the prepared file to the following path:  
Installation Path \ Apache Software Foundation \ Apache2.2 \ htdocs.



### **NOTE:**

- If put the prepared file under the folder "htdocs", the URL format to access the Apache server is: *http:// The IP address of the PC that installed with the Apache server .e.g.:* <http://192.169.1.51>
- If put the prepared file under the subfolder of the folder "htdocs", the URL format to access the Apache server is: *http:// The IP address of the PC that installed with the Apache server/subfolder Name. e.g.:* <http://192.169.1.51/filename>



### UPGRADE WITH TFTP SERVER

1. Unzip the firmware file, set the folder to save the firmware file to the root directory of TFTP server;
2. Connect the PC with the TFTP server and the GVR to the same LAN;
3. Start the TFTP server and go to file menu->Configure->Security and set to "Transmission Only";
4. Start the TFTP server and set the upgrade type to TFTP on Upgrade Settings page of the GVR3550;
5. Set the firmware server path as the PC IP address, which is the IP address of the TFTP server;
6. Click "Upgrade Now" and the device would restart automatically after the upgrade completed.

### UPGRADE WITH HTTP/HTTPS SERVER

1. Unzip the firmware file and place it under the "htdocs" directory of the TFTP server;
2. Start the TFTP server and set the upgrade type to TFTP on Upgrade Settings page of the GVR3550;
3. Set the firmware server path to the HTTP server IP address;
4. Click "Upgrade Now" and the device would restart automatically after the upgrade completed.

### MANUAL UPGRADE

The procedures to manual upgrade with downloaded firmware file:

1. Set the upgrade mode to "Manual Upload" on the Upgrade Settings page of the GVR3550;
2. Click on the "File" button in the "firmware path" entry to select the firmware file;
3. Click "Upgrade Now" to upload firmware as shown in figure below
4. The upgrade process would begin automatically after uploaded successfully. The GVR will automatically restart once upgrade finished.

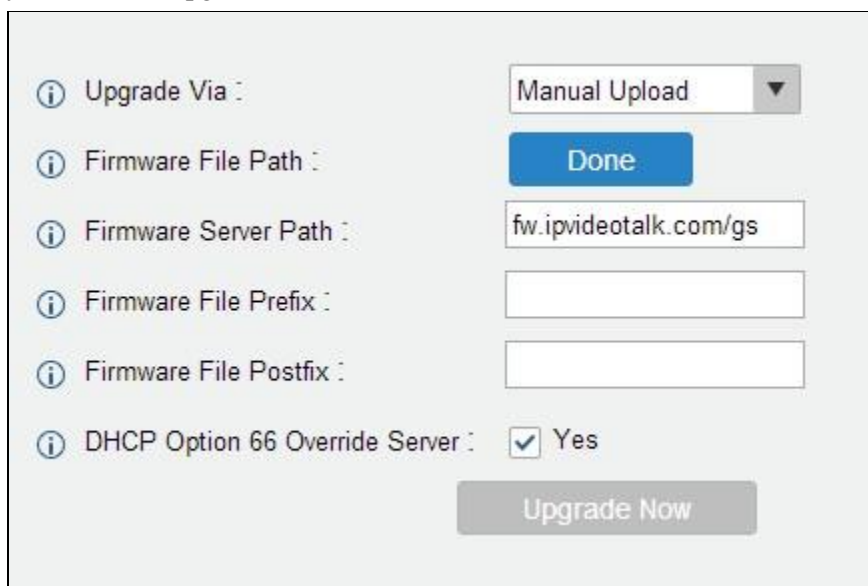

The screenshot shows the 'Manual Upload' configuration page for the GVR3550. It includes the following fields and controls:

- Upgrade Via :** A dropdown menu set to 'Manual Upload'.
- Firmware File Path :** A blue button labeled 'Done'.
- Firmware Server Path :** A text input field containing 'fw.ipvideotalk.com/gs'.
- Firmware File Prefix :** An empty text input field.
- Firmware File Postfix :** An empty text input field.
- DHCP Option 66 Override Server :** A checkbox that is checked, with the label 'Yes'.
- Upgrade Now :** A grey button at the bottom of the form.

**Figure 96: GVR3550 Web Page – Manual Update**

## FACTORY RESET

Users could reset factory settings via the following ways: Reset via local GUI, via Web page, via the reset button on the real panel of the GVR3550.



**WARNING!**

Factory Reset will erase all the GVR3550 configuration information. Please back up all devices or print related info before making the following steps. If users lost all parameters or records, Grandstream will take no responsibility for the damage or loss.

### **RESET VIA LOCAL GUI**

Users could go to Main Menu->Maintenance->Reset & Reboot on the GVR3550 local GUI, select "Erase All Data" or "Retain Network Data Only" and click on the "Reset" button to bring up the prompt box as shown below. Click "OK" to reboot the device and restore factory settings.

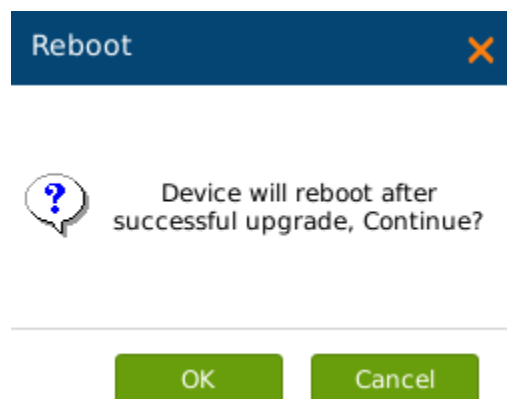

**Figure 97: GVR3550 Factory Reset Pop-up Page**

### **RESET VIA WEB PAGE**

Users could go to Main Menu->Maintenance->Reset & Reboot on the GVR3550 Web page. Select "Erase All Data" or "Retain Network Data Only" and click on the "Reset" button to bring up the prompt box as shown below. Click "OK" to reboot the device and restore factory settings.

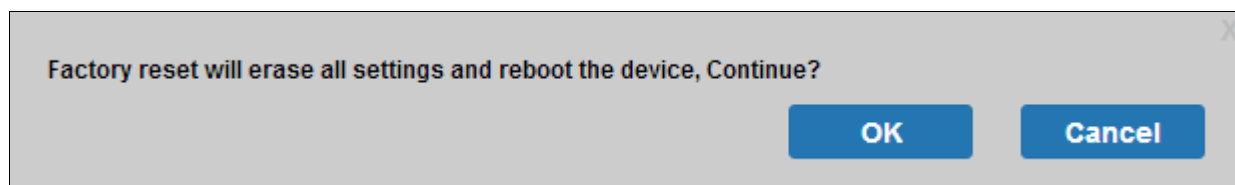

*Figure 98: GVR3550 Factory Reset on Local Web Page*

### ***RESET VIA BUTTON***

There is a Reset button on the real panel of the GVR3550 as shown in Figure 2, long press the button for more than 10 seconds to reboot and restore to factory reset.



## EXPERIENCING GVR3550

Please visit our website: <http://www.grandstream.com> to receive the most up-to-date updates on firmware releases, additional features, FAQs, documentation and news on new products.

We encourage you to browse our product related documentation, FAQs and User and Developer Forum for answers to your general questions. If you have purchased our products through a Grandstream Certified Partner or Reseller, please contact them directly for immediate support.

Our technical support staff is trained and ready to answer all of your questions. Contact a technical support member or submit a trouble ticket online to receive in-depth support.

Thank you again for purchasing Grandstream Enterprise Application phone, it will be sure to bring convenience and color to both your business and personal life. <http://www.grandstream.com>

## APPENDIX

### FAQs

The issues 1-21 might be caused by the reasons listed below each issue.

**1. *The GVR3550 is unable to start properly after normal startup***

Unmatched input power  
The power cables contact is not good  
Damaged power switch  
System upgrade errors  
Damaged HDD or HDD cables problem.  
Front panel error  
Damaged mainboard

**2. *The GVR3550 would reboot automatically or crashes frequently in a few minutes after startup***

Unstable input power or low voltage.  
No enough power  
Connection error of HDD power line  
Bad tracks or damaged HDD line.  
Power shortage  
Unstable IPC signal  
Poor heat dissipation, too much dust, poor running environment.  
Hardware failure

**3. *Undetected HDD after startup, it might be caused by the following reasons.***

Unconnected HDD power line  
Damaged HDD cable  
Connection error of HDD jumpers  
Damaged HDD  
Damaged SATA port on mainboard

**4. *No single camera/ Multi-camera/ video output***

Unmatched programs, please update the right system programme  
Image brightness is 0, please restore the default settings.  
Hardware failure

**5. *Unable to search record when local playback***

Damaged HDD cables or jumpers.  
Updated procedures varied from the original application file.  
Damaged HDD

HDD full

The record you want to search has been overwritten.

The record has not yet played

**6. *Dazzling monitor when search local record***

Wrong data reading, small code stream, full screen mosaic when playback, restart the GVR3550 will solve these issues in general.

Damaged HDD cable or jumpers.

HDD error

Hardware failure

**7. *Wrong Time Display***

Wrong settings

Poor contact of cell button or low voltage.

Crystal oscillator is unworkable

**8. *The GVR3550 can't monitor PTZ***

IPC PTZ error

Incorrect PTZ decoding settings, wiring, installation.

Incorrect cable connection

Incorrect PTZ settings

Unmatched PTZ decoder with the GVR3550 protocol

Unmatched PTZ decoder with the GVR3550 address

**9. *Unable to login the Web page***

Unable to install PC client or the page can't be displayed normally.

The operation systems are win98 or win me: It is recommended to update the operating system to win2000sp4 and higher.

Network connection error

Network settings

Incorrect username or password.

**10. *Mosaic or no images when preview or playback record***

Poor internet connection

Resource limitations on the PC client

The login user has no monitoring privilege.

**11. *Unstable internet connection***

Unstable network

IP address confliction

MAC address confliction

Unstable connection of network card on PC or on the GVR3550

**12. *USB backup error***

CPU usage is too high, please stop recording then backup.

Data volume exceeds backup capacity would cause backup error

Incompatible backup devices

Damaged backup devices

**13. Unable to close alarm signal**

Incorrect alarm settings  
Manually enabled alarm output  
Input device failure or wrong connection  
Version problems, upgrade to solve it.

**14. The alarm doesn't work**

Incorrect alarm settings  
Incorrect connection of the alarm cables  
Incorrect alarm input signal  
Two circuits having been connected to one alarm simultaneously

**15. Unable to control the GVR3550 via remote control**

Remote control distance is too far or the control angle is far too partial.  
Run-down batteries  
Damaged control/front panel

**16. Insufficient record time**

Large stream caused by poor quality of the front camera, dirty camera Lens, backlight installation, unadjusted iris.  
Insufficient HDD capacity  
Damaged HDD

**17. Unable to play downloaded file**

You have no installed player or unplugged the external storage device improperly.

**18. No image, black screen**

Check whether the IP of remote IPC is correct  
Check whether the port No. of remote IPC is correct  
Check whether the username/password of remote IPC is correct  
Check whether the internet connection of remote GVR3550 is correct

**19. Missing display screen**

Check the resolution the LCD supports. If the GVR resolution is 1920\*1080, the LCD should support 1920\*1080 resolution.

**20. No LCD HDMI output**

Check the HDMI cable and whether LCD works in HDMI mode

**21. Multi-camera monitoring record lag**

Please check the network bandwidth. Gigabit network is recommended. The computer suggested for multi-camera monitoring: Quad Core CPU, discrete graphics, 256M memory or higher.

## **RECORD TIME CALCULATION**

Please confirm the HDD has been installed when install the GVR3550 for the first time.

HDD Capacity formula is:

**Total Space (M) = The amount of cameras \* Required Time(Hour)\* The HDD space occupied per hour (M/H)**

From the formula above we could conclude the Record Time formula:

**Record Time (hour) = Total Space (M)/The HDD space occupied per hour (M/H) \*the amount of cameras**

The GVR3550 is equipped with MPEG4/H.264 compression technique, its dynamic range is quite large thus the HDD capacity calculation requires assessing the file size recorded per hour in each camera according to stream.

e.g.:

The record in one single camera takes up 2 MB/H per hour; use the GVR3550 to record with synchronous 12 cameras.

**Record Time (hour) = 2\*4\*1024\*1024/200 (M/H) \*12=3495.25 (Hour) ≈145.6 (Day)**